

Operating manual

# SUNNY HOME MANAGER 2.0

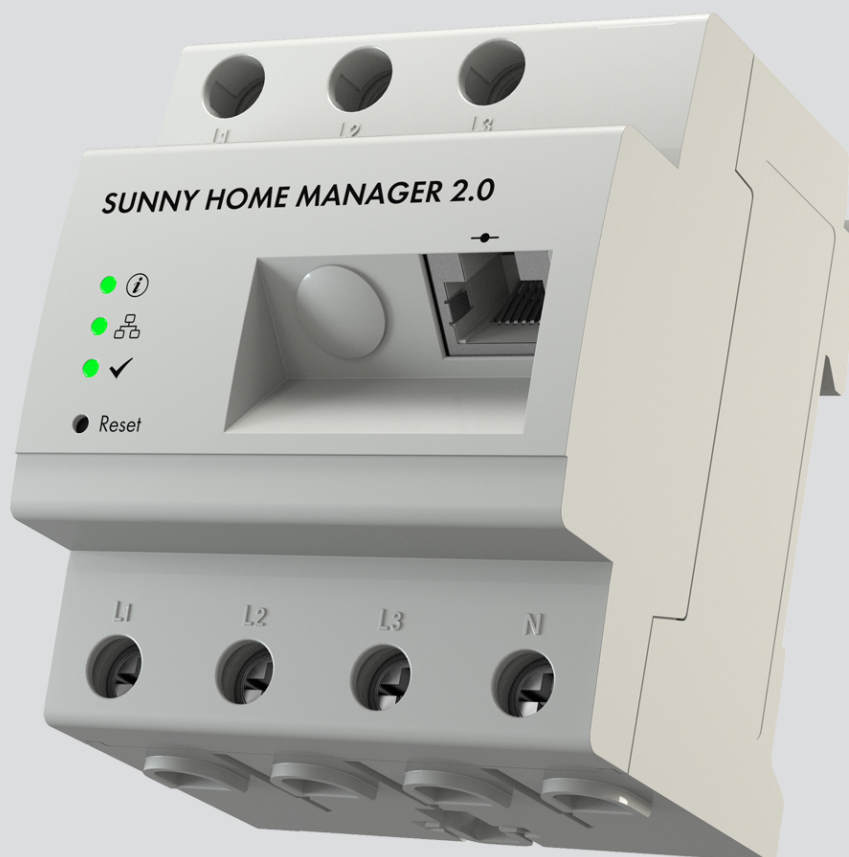

## Legal Provisions

The information contained in these documents is the property of SMA Solar Technology AG. No part of this document may be reproduced, stored in a retrieval system, or transmitted, in any form or by any means, be it electronic, mechanical, photographic, magnetic or otherwise, without the prior written permission of SMA Solar Technology AG. Internal reproduction used solely for the purpose of product evaluation or other proper use is allowed and does not require prior approval.

SMA Solar Technology AG makes no representations or warranties, express or implied, with respect to this documentation or any of the equipment and/or software it may describe, including (with no limitation) any implied warranties of utility, merchantability, or fitness for any particular purpose. All such representations or warranties are expressly disclaimed. Neither SMA Solar Technology AG nor its distributors or dealers shall be liable for any indirect, incidental, or consequential damages under any circumstances.

The exclusion of implied warranties may not apply in all cases under some statutes, and thus the above exclusion may not apply.

Specifications are subject to change without notice. Every attempt has been made to make this document complete, accurate and up-to-date. Readers are cautioned, however, that product improvements and field usage experience may cause SMA Solar Technology AG to make changes to these specifications without advance notice or per contract provisions. SMA Solar Technology AG shall not be responsible for any damages, including indirect, incidental or consequential damages, caused by reliance on the material presented, including, but not limited to, omissions, typographical errors, arithmetical errors or listing errors in the content material.

### SMA Warranty

You can download the current warranty conditions from the Internet at [www.SMA-Solar.com](http://www.SMA-Solar.com).

### Software licenses

The software licenses for the installed software modules are contained in the Sunny Home Manager software. Upon connection of the Sunny Home Manager with a web browser, you will find the licenses at the following address: [http://IP\\_address/legal\\_notices.txt](http://IP_address/legal_notices.txt). The IP address (e.g. 192.168.1.120) will be assigned by your router for the Sunny Home Manager. You will find further information on determining the IP address in your router documentation.

### Trademarks

All trademarks are recognized, even if not explicitly identified as such. Missing designations do not mean that a product or brand is not a registered trademark.

### SMA Solar Technology AG

Sonnenallee 1

34266 Niestetal

Germany

Tel. +49 561 9522-0

Fax +49 561 9522-100

[www.SMA.de](http://www.SMA.de)

Email: [info@SMA.de](mailto:info@SMA.de)

As of: 12/2/2020

Copyright © 2020 SMA Solar Technology AG. All rights reserved.

## Table of Contents

<b>1</b>	<b>Information on this Document</b>	<b>7</b>
1.1	Validity	7
1.2	Target Group	7
1.3	Levels of Warning Messages	7
1.4	Symbols in the Document	7
1.5	Typographical Elements in the Document	8
1.6	Designations in the Document	8
1.7	Additional Information	8
<b>2</b>	<b>Safety</b>	<b>10</b>
2.1	Intended Use	10
2.2	IMPORTANT SAFETY INSTRUCTIONS	11
2.3	Cyber Security	12
<b>3</b>	<b>Scope of Delivery</b>	<b>14</b>
<b>4</b>	<b>Product Overview</b>	<b>15</b>
4.1	Product Description	15
4.2	Symbols on the Product	15
4.3	Light-Emitting Diodes (LEDs)	16
4.4	Additional components for operating the Sunny Home Manager	17
4.4.1	Basic Operation	17
4.4.2	Operation of a PV system with SMA inverters	17
4.4.3	Operation of a PV system with third-party inverters	18
4.4.4	Maximum Number of Supported Devices	18
4.4.5	Components for the control of loads	19
<b>5</b>	<b>Functions</b>	<b>20</b>
<b>6</b>	<b>System Structure</b>	<b>22</b>
6.1	System Requirements	22
6.2	System Topology	22
<b>7</b>	<b>Mounting</b>	<b>24</b>
7.1	Requirements for Mounting the Sunny Home Manager	24
7.2	Mounting the Sunny Home Manager on the Top-Hat Rail	24
<b>8</b>	<b>Connection</b>	<b>25</b>
8.1	Safety during Electrical Connection	25
8.2	Connecting the Voltage Supply	25
8.2.1	Requirements for connecting the voltage supply	25
8.2.2	Connecting the voltage supply with energy measurements of up to max. 63 A	26
8.2.3	Connecting the Voltage Supply with Energy Measurements greater than 63 A	27
8.3	Establishing communication to Sunny Portal	28
8.3.1	Preparing for Speedwire Communication	28
8.3.2	Connecting the Sunny Home Manager to the Router	28
8.3.3	Testing the Connection to Sunny Portal	29
<b>9</b>	<b>Getting Started</b>	<b>30</b>
9.1	Creating a Sunny Home Manager System in Sunny Portal	30
9.1.1	Registering in Sunny Portal	30
9.1.2	Creating a new PV System	31
9.1.3	Registering Sunny Home Manager and Adding Other Devices	31

9.1.4	Configuring the Energy Meter.....	32
9.1.5	Entering the System Data.....	33
9.2	Logging In and Out of Sunny Portal.....	35
9.3	User Interface of the Sunny Home Manager System.....	35
9.3.1	Accessing the user interface.....	35
9.3.2	Overview of the User Interface.....	36
9.3.3	Overview of Menus and Pages.....	36
9.3.4	Display of tables and diagrams.....	39
9.3.4.1	Setting the Display Period.....	39
9.3.4.2	Saving Diagram Data.....	39
9.3.4.3	Printing Diagram Data.....	39
<b>10</b>	<b>Configuration of the Sunny Home Manager system .....</b>	<b>40</b>
10.1	System data.....	40
10.1.1	System Data Overview.....	40
10.1.2	Changing System Data.....	40
10.1.3	Changing the System Name.....	41
10.1.4	Deleting the System.....	41
10.1.5	Entering the Nominal System Power.....	41
10.1.6	Changing/Deleting the System Image.....	42
10.2	String Configuration.....	42
10.3	Changing Operator Data.....	42
10.4	Configuring parameters.....	43
10.4.1	Entering the Feed-In Tariff and Electricity Tariff.....	43
10.4.2	Configuring Limitation of Active Power Feed-In.....	44
10.4.3	Activating/Deactivating Grid Management Services.....	46
10.4.4	Entering time period control for charging the battery-storage system.....	46
10.4.5	Setting the Optimization Target.....	47
10.4.6	Entering the Amount of CO2 Avoided.....	47
10.4.7	Entering the Expected Yield.....	48
10.5	Releasing Data.....	49
<b>11</b>	<b>Device Administration.....</b>	<b>50</b>
11.1	Device Overview Tab.....	50
11.1.1	Filtering the Device Overview.....	51
11.1.2	Configuring the Device Properties.....	51
11.1.3	Changing Device Names and Description.....	52
11.1.4	Activating/Deactivating Data Collection.....	53
11.2	Overview of New Devices Tab.....	54
11.2.1	Adding or Replacing Devices.....	54
11.3	Configuring the Sunny Home Manager.....	55
11.3.1	Simple or Extended Configuration.....	56
11.3.2	Setting Automatic Updates.....	56
11.3.3	Configuring AVM FRITZ!Box Smart Home Control.....	56
11.3.4	Setting the Edimax Smart Plug.....	57
11.3.5	Enabling System Communication Monitoring.....	57
11.3.6	Setting the Data Request Interval.....	57
11.3.7	Activating SMA Smart Home.....	58
11.3.8	Configuring the External Current Transformer.....	59
11.3.9	Reconfiguring the Energy Meter.....	59
11.4	Adding and Configuring the Inverter.....	60
11.4.1	Adding an Inverter.....	60
11.4.2	Entering Line Conductors.....	60
11.4.3	Entering the PV Array Power.....	60
11.4.4	Configuring Strings.....	61
11.5	Adding a Radio-Controlled Socket.....	62

11.6	Replacing the Sunny Home Manager.....	63
11.6.1	Resetting the Sunny Home Manager.....	64
11.6.2	Reassigning the Sunny Home Manager to the Sunny Portal System after the Reset.....	64
11.7	Deleting devices from Sunny Portal.....	65
<b>12</b>	<b>Load Control .....</b>	<b>66</b>
12.1	Background Information.....	66
12.2	Configuring Radio-Controlled Sockets .....	67
12.2.1	Safety when Configuring Radio-controlled Sockets.....	67
12.2.2	Requirements for Configuring Radio-Controlled Sockets.....	68
12.2.3	Selecting the Load.....	68
12.2.4	Entering the Device Name.....	68
12.2.5	State of the radio-controlled socket after load operation.....	69
12.2.6	Configuring the Operating Mode.....	69
12.2.7	Configuring Start-up Detection .....	69
12.3	Load Overview and Planning .....	70
12.4	Configuring Load Characteristics .....	72
12.4.1	Entering general information .....	72
12.4.2	Selecting the Load Type.....	73
12.4.3	Selecting Program Controllability.....	73
12.4.4	Entering the Power Consumption .....	73
12.4.5	Entering the Maximum Program Operating Time .....	74
12.4.6	Entering the Minimum Switch-On and Switch-Off Time .....	74
12.4.7	Setting the Priority of the Load.....	74
12.5	Controlling Loads via the Radio-Controlled Socket.....	75
12.5.1	Assigning Radio-Controlled Sockets .....	75
12.5.2	Setting Measuring and Switching of the Radio-Controlled Socket.....	76
12.6	Setting Automatic Switch-Off .....	76
12.7	Configuring the Time Period.....	77
12.8	Directly Controlling Loads.....	79
12.9	Application example forecast-based battery charging.....	80
12.9.1	Objective and Background Information .....	80
12.9.2	Setting up Forecast-Based Battery Charging.....	81
<b>13</b>	<b>Visualization of the energy management.....</b>	<b>83</b>
13.1	System selection with system list .....	83
13.2	System overview .....	84
13.3	Current Status And Forecast .....	84
13.3.1	Overview Current Status Area .....	85
13.3.2	Overview Forecast and Recommended Action Area .....	86
13.4	Energy Balance.....	87
13.5	Load Balance and Control.....	90
13.5.1	Overview load balance and control.....	90
13.5.2	Selecting the Load Display .....	93
13.6	Display of the nominal system power .....	94
13.6.1	System yield in the annual comparison .....	94
13.6.2	Nominal system power analysis .....	96
13.6.2.1	Overview analysis.....	96
13.6.2.2	Setting the Device Selection .....	98
<b>14</b>	<b>Monitoring of the Sunny Home Manager system .....</b>	<b>99</b>
14.1	Overview of system monitoring .....	99
14.1.1	Communication Monitoring.....	99
14.1.2	Inverter Comparison .....	99
14.1.3	SMA Smart Connected.....	100

14.1.4	Further PV System Monitoring Options.....	100
14.2	Configuring PV System Monitoring .....	101
14.2.1	Setting Communication Monitoring .....	101
14.2.2	Setting the Inverter Comparison.....	101
14.2.3	Activating SMA Smart Connected.....	102
14.2.4	Filter and confirm messages in the system logbook.....	102
14.2.5	Configuring Reports .....	103
<b>15</b>	<b>Presentation of the Sunny Home Manager system.....</b>	<b>106</b>
15.1	PV System Profile .....	106
15.2	Make PV system profile publicly available .....	106
15.3	Releasing and publishing pages.....	106
15.4	Specifying the System Home Page.....	107
<b>16</b>	<b>User Management .....</b>	<b>108</b>
16.1	User Groups and User Rights .....	108
16.2	Creating a New User.....	109
16.3	Deleting a User.....	110
16.4	Changing User Rights.....	110
16.5	Changing User Information.....	110
<b>17</b>	<b>Password Information .....</b>	<b>111</b>
17.1	Requirements for a Secure System Password .....	111
17.2	Required Passwords .....	111
17.3	Changing Passwords.....	112
17.4	Procedure in Case of Forgotten Passwords .....	112
<b>18</b>	<b>Troubleshooting.....</b>	<b>114</b>
18.1	Error messages general.....	114
18.2	Errors during Registration in Sunny Portal.....	115
18.3	Error message on the Sunny Home Manager .....	118
18.4	Problems when Configuring and Controlling Radio-Controlled Sockets.....	119
18.5	Incomplete/Outdated/Faulty Data on the User Interface .....	120
18.6	Network problems.....	122
18.6.1	Using the Sunny Home Manager Assistant in case of network problems.....	122
18.6.2	Error in the Sunny Home Manager Assistant.....	123
18.7	Messages concerning Active Power Limitation in the System Logbook.....	123
18.8	Devices with Communication via Data Exchange Protocol .....	124
<b>19</b>	<b>Decommissioning .....</b>	<b>126</b>
19.1	Decommissioning the Sunny Home Manager .....	126
19.2	Packing the Product for Shipment.....	126
19.3	Disposing of the Product .....	126
<b>20</b>	<b>Appendix .....</b>	<b>127</b>
20.1	List of Compatible SMA Inverters .....	127
<b>21</b>	<b>Technical Data .....</b>	<b>128</b>
<b>22</b>	<b>Contact .....</b>	<b>130</b>

# 1 Information on this Document

## 1.1 Validity

This document is valid for:

- Sunny Home Manager 2.0 from software package 2.3.0.R

## 1.2 Target Group

This document is intended for qualified persons and end users. Only qualified persons are allowed to perform the activities marked in this document with a warning symbol and the caption "Qualified person". Tasks that do not require any particular qualification are not marked and can also be performed by end users. Qualified persons must have the following skills:

- Training in how to deal with the dangers and risks associated with installing, repairing and using electrical devices and installations
- Training in the installation and commissioning of electrical devices and installations
- Knowledge of all applicable laws, standards and directives
- Knowledge of and compliance with this document and all safety information

## 1.3 Levels of Warning Messages

The following levels of warning messages may occur when handling the product.

### DANGER

Indicates a hazardous situation which, if not avoided, will result in death or serious injury.

### WARNING

Indicates a hazardous situation which, if not avoided, could result in death or serious injury.







### CAUTION

Indicates a hazardous situation which, if not avoided, could result in minor or moderate injury.

### NOTICE

Indicates a situation which, if not avoided, can result in property damage.

## 1.4 Symbols in the Document

Symbol	Explanation
	Information that is important for a specific topic or goal, but is not safety-relevant
	Indicates a requirement for meeting a specific goal
	Desired result
	A problem that might occur
	Example
	Sections describing activities to be performed by qualified persons only

## 1.5 Typographical Elements in the Document

Typography	Use	Example
<b>bold</b>	<ul style="list-style-type: none"> <li>• Messages</li> <li>• Terminals</li> <li>• Elements on a user interface</li> <li>• Elements to be selected</li> <li>• Elements to be entered</li> </ul>	<ul style="list-style-type: none"> <li>• Connect the insulated conductors to the terminals <b>X703:1</b> to <b>X703:6</b>.</li> <li>• Enter <b>10</b> in the field <b>Minutes</b>.</li> </ul>
>	<ul style="list-style-type: none"> <li>• Connects several elements to be selected</li> </ul>	<ul style="list-style-type: none"> <li>• Select <b>Settings &gt; Date</b>.</li> </ul>
[Button] [Key]	<ul style="list-style-type: none"> <li>• Button or key to be selected or pressed</li> </ul>	<ul style="list-style-type: none"> <li>• Select <b>[Enter]</b>.</li> </ul>
#	<ul style="list-style-type: none"> <li>• Placeholder for variable components (e.g., parameter names)</li> </ul>	<ul style="list-style-type: none"> <li>• Parameter <b>WClHz.Hz#</b></li> </ul>

## 1.6 Designations in the Document

Complete designation	Designation in this document
Sunny Home Manager 2.0	Sunny Home Manager, product

## 1.7 Additional Information

"SMA Smart Home" The System Solution for Greater Independence	Planning Guidelines
"SMA FLEXIBLE STORAGE SYSTEM with Battery-Backup Function" Increased Self-Consumption with Sunny Island and Sunny Home Manager	System description
"SMA SMART HOME - Load Control via MUST Time Period - Example: Washing Machine"	Technical Information
"SMA SMART HOME - Load Control via CAN Time Period - Example: Pool Pump"	Technical Information
"SMA SMART HOME Load Control Using Relays or Contactors - Example: Heating Rod"	Technical Information
"SMA SMART HOME - Battery Charging Management with Time-of-Use Energy Tariffs" Information on battery charging management for time-of-use energy tariffs and for configuring via Sunny Portal	Technical Information
"SMA SMART HOME - Compatibility List for Loads"	Technical Information



"SMA SMART HOME - Energy Management with Loads via EEBUS"      Technical Information

---

"PUBLIC CYBER SECURITY - Guidelines for a Secure PV System Communication"      Technical information

---

## 2 Safety

### 2.1 Intended Use

The Sunny Home Manager is the central device responsible for energy management in households with a photovoltaics (PV) system. The Sunny Home Manager makes the most of the solar power generated by the PV system by combining all suitable energy flows in the household to create an intelligent system and, upon request, control it automatically.

The online portal Sunny Portal is used to operate and configure the Sunny Home Manager. The user can make all the required and desired settings for their PV system here.

The Sunny Home Manager carries out the following basic tasks:

- Measuring of energy and power values
- Energy monitoring: Presenting the energy flows via Sunny Portal
- Energy management: Creation of yield forecasts using online weather forecasts and individual consumption analysis and optimization of energy efficiency through automatic control of loads in the household (this includes, for example, household appliances such as dishwashers, dryers, washing machines as well as heating and hot water preparation via heat pumps and heating elements, but also charging stations for e-mobility).
- Dynamic limiting of the active power feed-in

The Sunny Home Manager is not an energy meter for power consumption in the sense of the EU directive 2004/22/EG (MID). The Sunny Home Manager may not be used for billing purposes. The data collected by the Sunny Home Manager relating to the power generated by your PV system may deviate from the data of the main energy meter, which is used for billing purposes.

The Sunny Home Manager is approved for use in all EU member states and Australia.

The type label must remain permanently attached to the product.

### Environment

The product is designed for indoor use only.

The Sunny Home Manager may only be connected to the subdistribution of the household on the load side behind the energy meter of the electric utility company. The Sunny Home Manager must be installed in a switch cabinet or in a domestic installation cabinet in the area of the additional applications intended for this as per VDE-AR-N 4100:2019-04.

It is possible to use the Sunny Home Manager in delta IT grids. When using the Sunny Home Manager in delta IT grids, the cumulative power values are correctly measured. Due to the measuring principle of the Sunny Home Manager, other measured values may be incorrect.

### Statutory warranty

Use SMA products only in accordance with the information provided in the enclosed documentation and with the locally applicable laws, regulations, standards and directives. Any other application may cause personal injury or property damage.

Alterations to the SMA products, e.g., changes or modifications, are only permitted with the express written permission of SMA Solar Technology AG. Unauthorized alterations will void guarantee and warranty claims and in most cases terminate the operating license. SMA Solar Technology AG shall not be held liable for any damage caused by such changes.

Any use of the product other than that described in the Intended Use section does not qualify as the intended use.

The enclosed documentation is an integral part of this product. Keep the documentation in a convenient, dry place for future reference and observe all instructions contained therein.

This document does not replace and is not intended to replace any local, state, provincial, federal or national laws, regulations or codes applicable to the installation, electrical safety and use of the product. SMA Solar Technology AG assumes no responsibility for the compliance or non-compliance with such laws or codes in connection with the installation of the product.

## 2.2 IMPORTANT SAFETY INSTRUCTIONS

Keep the manual for future reference.

This section contains safety information that must be observed at all times when working.

The product has been designed and tested in accordance with international safety requirements. As with all electrical or electronic devices, there are residual risks despite careful construction. To prevent personal injury and property damage and to ensure long-term operation of the product, read this section carefully and observe all safety information at all times.

### DANGER

#### **Danger to life due to electric shock when live components or cables are touched**

High voltages are present in the conductive components or cables of the product. Touching live parts and cables results in death or lethal injuries due to electric shock.

- Disconnect the product from voltage sources and make sure it cannot be reconnected before carrying out any work on the product.
- Before carrying out any work on the product, disconnect the grid side from all voltage sources using the installed disconnect switch.
- Ensure that the conductors to be connected are de-energized.
- Clean the product with a dry cloth only.
- Only use the product in a dry environment and keep it away from moisture.
- Install the product in the switch cabinet only and ensure that the connection areas for the line conductors and the neutral conductor are behind a cover or have contact protection.
- Observe the prescribed minimum clearance between the network cable and live installation components, or use suitable insulation.

### DANGER

#### **Danger to life due to electric shock if external disconnect switch is missing**

High voltages are present in the conductive components. Touching live parts results in death or lethal injuries due to electric shock.

- Install an external disconnect switch between the product and the grid-connection point. The external disconnecter must be close to the product and easily accessible.
- Before carrying out any work on the product, disconnect the grid side from all voltage sources using the installed disconnect switch.

**⚠ WARNING****Danger to life due to electric shock**

Under fault conditions, when working on the power supply circuit there may be dangerous voltages present on the product. This can result in death or serious injury.

- For power supply units with a fixed connection, make sure that a disconnection unit (e.g. miniature circuit breaker) is present outside the power supply unit.
- For power supply units with a plug connection, make sure that the electrical outlet for the power supply unit is close to the power supply unit.
- The disconnection unit and the electrical outlet for the power supply unit must be freely accessible at all times.

**⚠ WARNING****Danger of fire due to missing or incorrect fuse**

If a fuse is missing or incorrect and a fault occurs, a fire may be caused. This can result in death or serious injury.

- Protect the line conductors of the product with a fuse or a selective circuit breaker with max. 63 A.

**⚠ WARNING****Danger to life by switching medical devices**

Unintentional switching of medical devices can result in life-threatening situations.

- Do not connect any medical devices to the radio-controlled socket.

**⚠ WARNING****Risk of injury and fire due to unintentional and unattended switching on of loads**

Loads that are switched on via a radio-controlled socket unintentionally and while unattended can cause injuries and fires (e.g. an iron).

- Do not connect any loads to the radio-controlled socket that could endanger persons or cause damage if unintentionally switched on.

**NOTICE****Damage to loads**

Frequently switching a load on and off can damage it.

- Ask the load manufacturer whether the load is suitable for control via a radio-controlled socket.
- Configure the radio-controlled socket so that the load connected is not switched on or off more frequently than specified by the load manufacturer.
- Do not connect any loads to the radio-controlled socket if they require a continuous current supply.

## 2.3 Cyber Security

Most operating activities such as monitoring and control of systems can be done locally by the PV system operator or service personnel without the need for data communication via public Internet infrastructure.

In other use cases of systems, the PV systems are also part of the global communication system, which is based on Internet infrastructures.

The data communication via Internet is an up-to-date, economically viable and customer-friendly approach in order to enable easy access for the following modern applications such as:

- Cloud platforms (e.g. Sunny Portal)

- Smartphones or other mobile devices (iOS or Android apps)
- SCADA systems, which are remotely connected
- Utility interfaces for grid management services

Alternatively, selected and secured communication interfaces may be used. These solutions are no longer state of the art and are very expensive to use (special communication interfaces, separate wide area networks and more).

When using the Internet infrastructure, the systems connected to the Internet are entering a basically unsecure area. Potential attackers constantly seek vulnerable systems. Usually, they are criminally motivated, have a terrorist background or aim to disrupt business operations. Without taking any measures to protect systems and other systems from such misuse, a data communication system should not be connected to the Internet.

Communication between the SMA internet platform Sunny Portal and the Sunny Home Manager takes place via the Webconnect process as well as the HTTPS protocol, i.e. an authenticated and encrypted connection and thus allows safe online communication.

You can find the current recommendations by SMA Solar Technology AG on the topic of Cyber Security in the Technical Information "PUBLIC CYBER SECURITY - Guidelines for a Secure PV System Communication" at [www.SMA-Solar.com](http://www.SMA-Solar.com).

### 3 Scope of Delivery

Check the scope of delivery for completeness and any externally visible damage. Contact your distributor if the scope of delivery is incomplete or damaged.

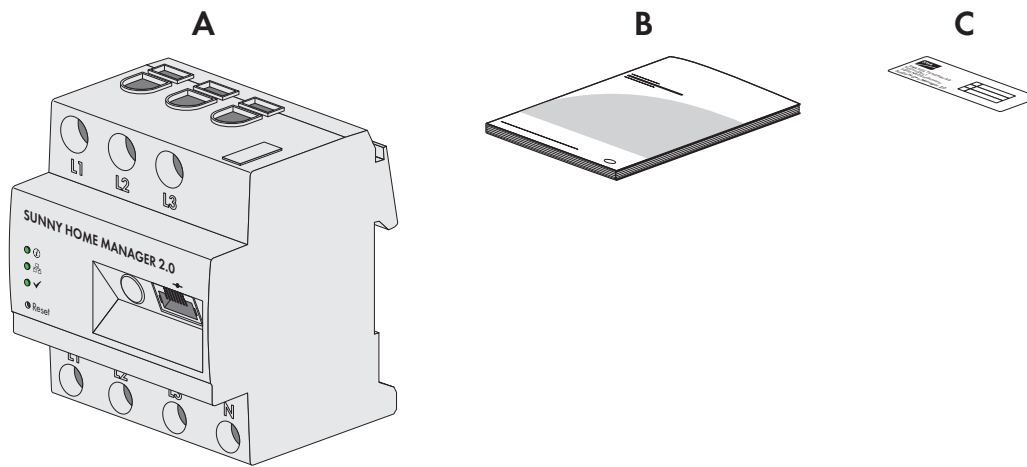

Figure 1: Components included in scope of delivery

Position	Quantity	Designation
A	1	Sunny Home Manager
B	1	Quick reference guide for commissioning
C	1	Label with serial number (SN), registration ID (RID) and identification key (PIC) for registration of the device by means of the setup assistant in the Sunny Portal

## 4 Product Overview

### 4.1 Product Description

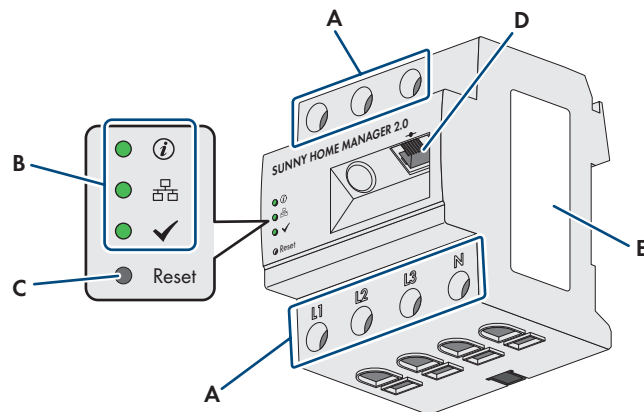

Figure 2: Sunny Home Manager 2.0

Position	Designation
A	Connection area for line conductors and neutral conductor
B	Light-emitting diodes
C	Reset button
D	Network terminal (Speedwire/Ethernet)
E	Type Label

### 4.2 Symbols on the Product

Symbol	Explanation
—●—	SMA Speedwire (Ethernet)





#### Type Label

The type label clearly identifies the product. The type label is located on the side of the product and must remain permanently attached to the product. You will find the following information on the type label:

- Assembly name
- Hardware version (Version)
- Serial number (SN)
- Registration ID (RID)
- Identification key (PIC)
- MAC address (MAC)

You will require the information on the type label to use the product safely and when seeking customer support from Service (see Section 22 "Contact", page 130).

### Symbols on the type label

Symbol	Explanation
	RCM (Regulatory Compliance Mark) The product complies with the requirements of the applicable Australian standards.
	WEEE designation Do not dispose of the product together with the household waste but in accordance with the disposal regulations for electronic waste applicable at the installation site.
	Protection class II The product has a reinforced or double insulation between grid current circuit and output voltage.
	Qualified person The product may only be installed by a qualified person.
	Data matrix code 2D code for device-specific characteristics

### 4.3 Light-Emitting Diodes (LEDs)

The LEDs indicate the operating state of the product.

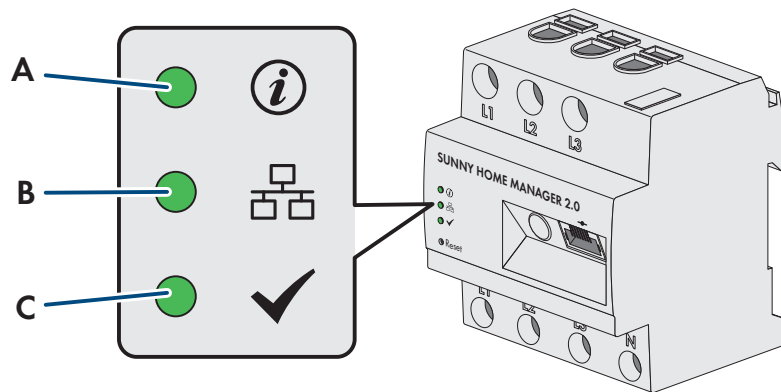





Figure 3: LEDs of the Sunny Home Manager

Position	LED symbol	Designation	Explanation
A		Status LED	Displays the operating state of the Sunny Home Manager (operation, startup process, error status)
B		COM LED	Displays the status of the Ethernet connection to the router
C		Performance LED	Displays the operating state, energy management, portal connection and error status.



## Sunny Home Manager operating states

LED	Status and meaning
Status LED	<p><b>Glowing green:</b> Sunny Home Manager is switched on.</p> <p><b>Flashing green:</b> Firmware is being updated.</p> <p><b>Glowing red:</b> Sunny Home Manager is starting up.</p> <p><b>Flashing red:</b> No connection to Sunny Portal.</p>
COM LED	<p><b>Off:</b> No Ethernet connection.</p> <p><b>Glowing green:</b> Ethernet connection is established.</p> <p><b>Flashing green:</b> The Sunny Home Manager is sending or receiving data.</p>
Performance LED	<p><b>Off:</b> Sunny Home Manager is not registered in Sunny Portal</p> <p><b>Flashing green:</b> Energy management in the Sunny Home Manager running smoothly.</p> <p><b>Flashing green:</b> An error has occurred. The error has already been reported to Sunny Portal.</p> <p><b>Glowing red:</b> An error has occurred. The error has not yet been reported to Sunny Portal.</p> <p><b>Flashing red:</b> No connection to Sunny Portal.</p>

## 4.4 Additional components for operating the Sunny Home Manager

### 4.4.1 Basic Operation

The following additional components are required for operating the Sunny Home Manager:

- Internet access via router (for Sunny Portal connection)
- PC with web browser
- Sunny Portal access

#### Router

The Sunny Home Manager establishes the internet connection to Sunny Portal via a router/network switch. Via the Ethernet connection of the Sunny Home Manager (Speedwire) to the router, the data read out by the integrated measuring device of the Sunny Home Manager from all devices integrated in the system is sent to the Sunny Portal. The user can make all the required settings for the Sunny Home Manager system via Sunny Portal.

#### Sunny Portal

Sunny Portal is the central user interface for the Sunny Home Manager.

The Sunny Portal system setup assistant is used to commission the Sunny Home Manager (go to [www.sunnyportal.com/register](http://www.sunnyportal.com/register) (see Section 9.1.1, page 30))

### 4.4.2 Operation of a PV system with SMA inverters

The Sunny Home Manager organizes the electricity generated by the PV system and provided by inverters within the loads in the household. The Sunny Home Manager regulates the feed-in of the (residual) current into the utility grid at the point of interconnection.

PV inverters can communicate in two different ways with the Sunny Home Manager:

- Wired via SMA Speedwire/Ethernet  
The inverter must be connected to the local network via a network cable (e.g. via a router).

- Wireless via SMA Speedwire/Wi-Fi

The Sunny Home Manager does not have a Wi-Fi connection, however it can communicate with all devices connected to the same router.

Depending on the ambient conditions, wireless networks can have a limited range. In free-field conditions without any disruptive objects, a high radio range is possible. Inside buildings, obstacles such as walls, ceilings and doors or other sources of interference can reduce the range to a few meters. Range problems can be eliminated with standard WLAN repeaters.

The Sunny Home Manager supports all PV inverters with integrated or retrofitted Speedwire interface of SMA Solar Technology AG. The PV inverters must have the current firmware version in each case (see the inverter product page at [www.SMA-Solar.com](http://www.SMA-Solar.com)).

### 4.4.3 Operation of a PV system with third-party inverters

For the operation of the Sunny Home Manager with third-party inverters, an SMA Energy Meter as a PV generation meter is required.

- The power output of the inverters must be captured via a separate SMA Energy Meter.
- The SMA Energy Meter must be configured in Sunny Portal as a PV generation meter.

If third-party inverters are also used in the PV system, the SMA Energy Meter handles the recording of the generated PV energy. In hybrid systems with SMA inverters and inverters from other manufacturers, the generated energy of **all** inverters is measured via the energy meter since it is used as the central PV generation meter. As soon as you have registered and configured a PV generation meter in the Sunny Home Manager system, the Sunny Home Manager will no longer query the power data of the SMA inverters directly from the inverters via Speedwire, but will receive the power data from the PV generation meter.

Monitoring of the PV system and the dynamic limitation of the active power fed into the utility grid are **not** possible with inverters from other manufacturers. In this case, verify whether operation of the PV system without dynamic active power limitation is permitted in the given country, or whether dynamic active power limitation can be performed independently by the inverter itself.

### 4.4.4 Maximum Number of Supported Devices

The Sunny Home Manager supports a **maximum of 24 devices**.

The term device includes all components that exchange data with the Sunny Home Manager, i.e. SMA inverters (including 1 battery inverter per system at most), radio-controlled sockets, and smart loads. The SMA Energy Meter is not included in these devices.

**Of the 24 devices, a maximum of 12 devices may be actively controlled by the Sunny Home Manager.**

Actively controlled means that the Sunny Home Manager not only displays the consumption of the device, but actively switches the device. Even if the limit of a maximum of 12 devices is reached, further devices can be monitored via radio-controlled sockets and visualized, so long as the maximum number of devices of 24 is not exceeded.



#### Fully equipped energy management system

A fully equipped energy management system (with a maximum of 24 devices) can consist of the following components:

- 3 x SMA Inverters
- 1 x heat pump  
that is controlled by the Sunny Home Manager via a direct data connection (e.g. SEMP).

- 20 x radio-controlled sockets

Due to the actively controlled heat pump, only a maximum of 11 of these radio-controlled loads can be actively controlled by the Sunny Home Manager. The loads connected to the other 9 radio-controlled sockets cannot be actively controlled by the Sunny Home Manager; only the consumption data are recorded.

## 4.4.5 Components for the control of loads

At least one of the following compatible components must be present to control loads:

- SMA radio-controlled socket
- Directly communicating load with EEBus or SEMP protocol interface

### SMA radio-controlled socket

Simple devices that do not have a directly communicating data connection can be integrated into the energy management system as an intermediate switch via radio-controlled sockets. The radio-controlled socket can then switch the loads on and off via control signals from the Sunny Home Manager.

At which times the Sunny Home Manager switches the radio-controlled socket on or off automatically and without any further manual operation depends on the configuration of the load and the current load planning configured in the Sunny Portal:

The Sunny Home Manager can measure the power consumption and length of the power consumption of individual loads connected to a radio-controlled socket and transmits these measured values to Sunny Portal. There, you can control specific loads so that they are switched on if a lot of PV power is available, for example.

In addition, radio-controlled sockets can be used purely for monitoring purposes - to measure the energy consumption of individual loads.

The Sunny Home Manager supports different radio-controlled sockets available from electronics retailers:

- A list of compatible radio-controlled sockets can be found, for example, in the technical information "SMA SMART HOME - Compatibility List for Loads" at [www.SMA-Solar.com](http://www.SMA-Solar.com).

### Compatible end devices

To control directly communicating loads, a compatible EEBus or SEMP (Simple Energy Management Protocol) interface must exist between the devices and the Sunny Home Manager.

Links to additional information can be found at [www.SMA-Solar.com](http://www.SMA-Solar.com):

- Devices with EEBUS interface (see technical information "SMA SMART HOME - Energy Management with Loads via EEBUS" and technical information "SMA SMART HOME - Compatibility List for Loads")
- Devices with SEMP interface (see planning guidelines "SMA Smart Home" and technical information "SMA SMART HOME - Compatibility List for Loads")

 SMA offers the option to use the protocol interface SEMP under <https://www.sma.de/produkte/sma-developer.html>.

## 5 Functions

The field of applications for the Sunny Home Manager ranges from its use as a simple energy meter to monitoring a PV system and intelligent energy management.

### Sunny Home Manager as energy meter

The Sunny Home Manager can detect energy flows in both directions:

- Continuous recording of the energy generated by the PV system
- At the point of interconnection, measurement of the feed-in of the generated energy into and the consumption of energy from the utility grid

### Sunny Home Manager in systems without self-consumption

#### Monitoring

- Basic PV system status monitoring to confirm correct system performance:  
All energy flows are recorded, evaluated, disturbances identified at an early stage and you are notified of disturbances.

#### Limitation of Active Power Feed-In

Local legal regulations, for example the Renewable Energy Sources Act (EEG) in Germany, can call for permanent limitation of active power feed-in for your PV system - that is, a limitation of the active power fed into the utility grid to a fixed amount or a percentage share of the installed nominal PV system power.

- The Sunny Home Manager monitors the active power that is fed into the utility grid. If the active power feed-in exceeds the prescribed limit, the Sunny Home Manager limits the PV generation of the inverters accordingly.

### Sunny Home Manager in systems with self-consumption

#### Monitoring and prognosis

- Creation of a PV generation forecast - based on the location-based weather forecast
- Creation of a load profile - based on time-dependent energy consumption:  
Taking the different electricity prices into account, the Sunny Home Manager uses this to derive recommendations for the prudent use of electrical energy and you can save electricity costs by manually switching on loads when the prices are low.  
To learn the load profile, the consumption data should be estimated over a period of at least 2 weeks.
- The forecast generated by the Sunny Home Manager is calculated from the estimated energy balance from generation and consumption for the next 48 hours.

#### Increase self-consumption

Self-consumption means that the energy produced by your PV system is consumed at the site where it is generated. Self-consumption reduces the amount of energy that you feed into the utility grid, but also the amount of energy that you purchase from your grid operator. This means, that with self-consumption, only the PV energy not used by yourself is fed into the utility grid.

The Sunny Home Manager measures power consumption levels of all connected loads and records exactly how much power a device has used and for how long. It uses this individual load profile combined with the location-based weather forecast to support your increased self-consumption:

#### Optimized self-consumption through load control:

- To control loads, there are the following options:
  - Control of simple, not directly communicating loads via radio-controlled sockets as "intermediate switches"
  - Control of directly communicating loads via the standard protocol interfaces EEBus or SEMP
- The Sunny Home Manager switches home appliances on automatically when the sun provides energy.

**Optimized self-consumption through dynamic active power limitation:**

- Through forecast-based load control, the Home Manager ensures that even on sunny days "excess" energy hardly ever gets lost since it has to be "curtailed" due to the limitation of the active power.
- When using SMA battery inverters, the Sunny Home Manager prevents derating losses that can be caused by limiting the active power feed-in: Taking the PV generation forecast and the consumption forecast into account, the time and duration of battery charging are chosen so that the battery is charged when excess PV energy cannot otherwise be used.

**Increased self-consumption through forecast-based battery charging:**

- The Sunny Home Manager increases the efficiency of your PV system by storing the excess energy generated during the midday peak, which is not allowed to be fed into the utility grid due to the active power limitation, in batteries:  
By means of the location-based weather forecast, the Sunny Home Manager can predict the solar irradiation for some hours to days and check whether derating losses due to the limitation of PV grid feed-in are to be expected for the current or following day. This means that in the afternoon of the current day only as much PV energy is charged to the battery as to ensure that, with the remaining battery charge, grid-supplied power at night (devices also run at night!) and on the morning of the next day can be avoided. Any derating losses forecast for the following day are avoided by the free storage capacity of the more heavily discharged battery.
- Having access to all key loads, the optional battery-storage system and the PV generation unit, the Sunny Home Manager always knows how much energy is available and where it is needed. In this way, it ensures automatically or via appropriate recommendations, that the connected home appliances are almost always supplied with inexpensive PV energy.

## 6 System Structure

### 6.1 System Requirements

#### Router:

A router/network switch connects the Sunny Home Manager via the Internet to Sunny Portal.

SMA Solar Technology AG recommends a permanent Internet connection (flat rate) and the use of a router that supports the dynamic assignment of IP addresses (DHCP – Dynamic Host Configuration Protocol), e.g. a Fritz!Box. All network components used must support the IGMP protocol, minimum version 3 (IGMPv3). If Ethernet network switches are used in the system, these should not perform "IGMP snooping". This is the case with most simple switches; this function must be turned off for higher-quality "managed" network switches. Using media couplers such as powerline adaptors can cause transmission problems. Usually, a firmware update of the manufacturer makes these devices compatible with multicast operation.

Should problems occur while registering in the network, SMA Solar Technology AG recommends the "Home Manager Assistant" software (available free of charge in the download area at [www.SMA-Solar.com](http://www.SMA-Solar.com)).

#### Supported web browsers:

The Sunny Home Manager uses the Sunny Portal as an operating and visualization surface. Sunny Portal supports all major web browsers.

#### Recommended display resolution of PCs connected to Sunny Portal:

- Minimum 1024 pixels x 768 pixels

#### Network cable requirements:

- Cable length between two nodes: max. 50 m with patch cable, max. 100 m with installation cable
- Cross-section: at least  $2 \times 2 \times 0.22 \text{ mm}^2$  ( $2 \times 2 \times 24 \text{ AWG}$ )
- Cable category: Cat5, Cat5e, Cat6, Cat6a, Cat7
- Cable shield: SF/UTP, S/UTP, SF/FTP, S/FTP
- Plug type: RJ45 of Cat5, Cat5e, Cat6, Cat6a

### 6.2 System Topology

The Sunny Home Manager has an integrated measuring device that provides the electrical measured values for PV generation at the point of interconnection, for grid feed-in, and for grid-supplied power as a cumulative value across the phases for the entire household.

SMA Solar Technology AG recommends using the Sunny Home Manager for measuring at the point of interconnection. Measuring occurs bi-directionally. Thus, the purchased electricity and grid feed-in can be measured. For the function **Limiting of the active power feed-in**, at least one measurement at the grid-connection point is required.

The Sunny Home Manager receives the measured data for PV generation, grid feed-in and purchased electricity via the integrated measuring device or from the connected SMA inverters directly via the data connection or a separate SMA Energy Meter optionally connected.

**Operation of the PV system with SMA inverters**  
**Measuring all energy flows with the Sunny Home Manager at the point of interconnection**

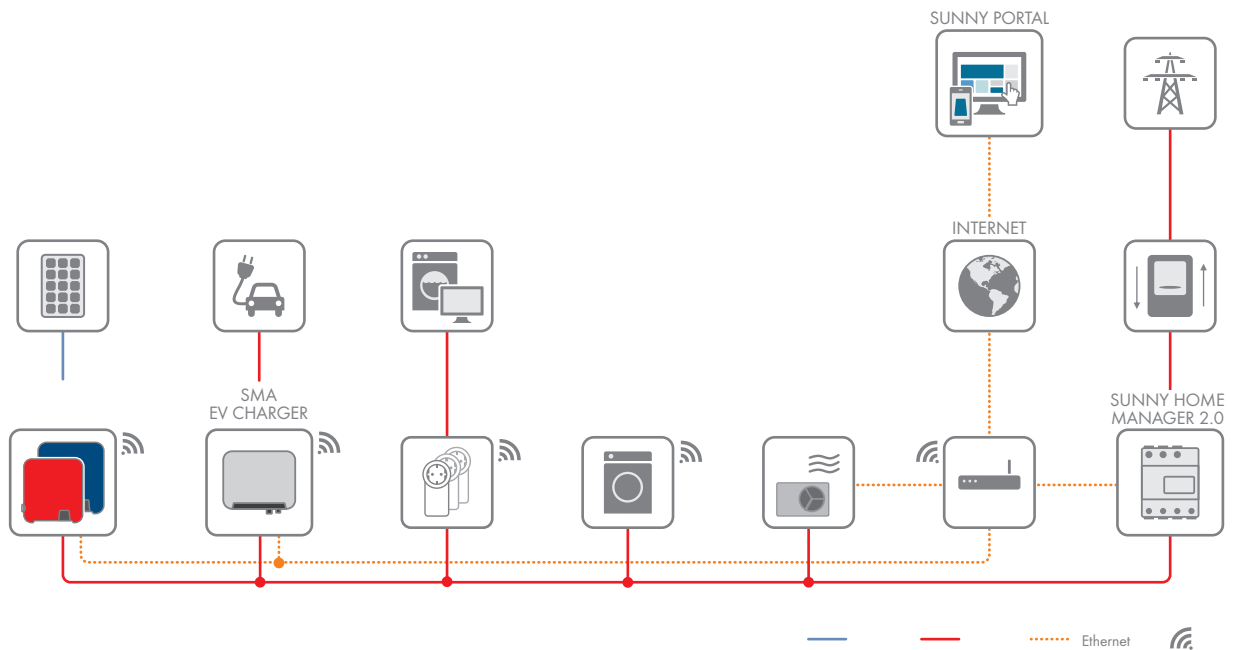

Figure 4: Topology with SMA inverters (example)

**Operation of the PV system with third-party inverters and use of an SMA Energy Meter**

The SMA Energy Meter is used to measure the PV power generation. With this system configuration, the Sunny Home Manager is also located at the point of interconnection.

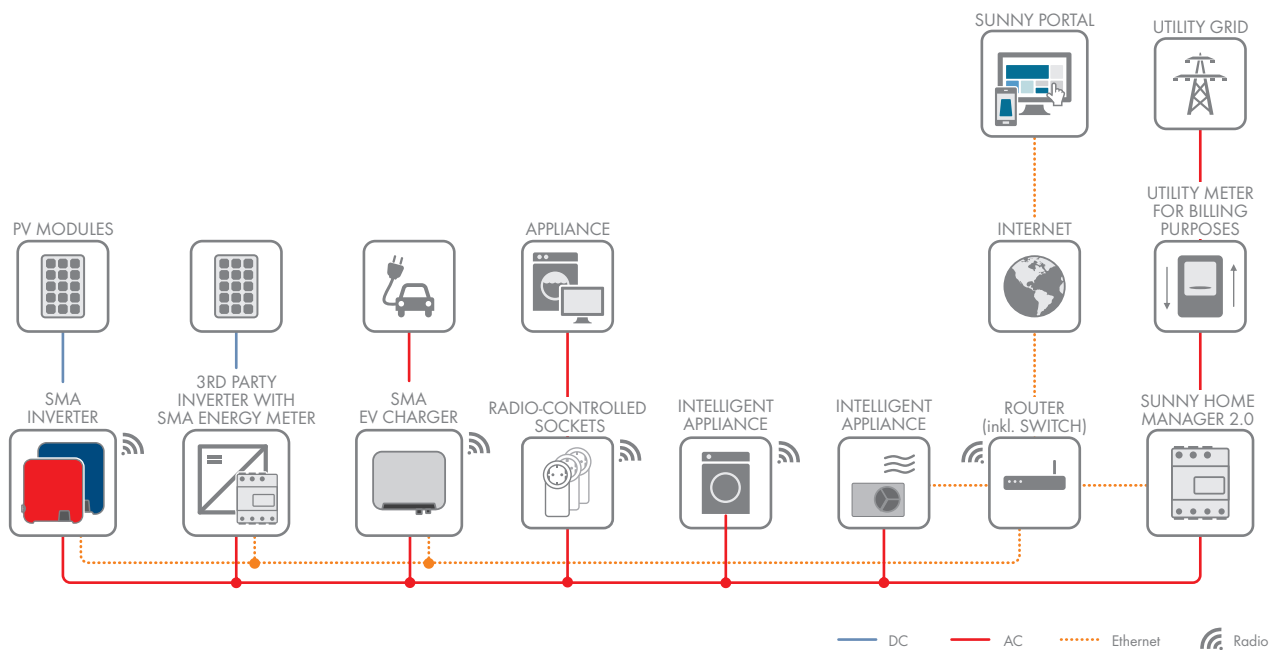

Figure 5: Topology with third-party inverters and use of an SMA Energy Meter

## 7 Mounting

### 7.1 Requirements for Mounting the Sunny Home Manager

- The mounting location must be indoors.
- The Sunny Home Manager must be installed in a switch cabinet.
- The mounting location must be protected against dust, moisture and corrosive substances.
- The cable route from the mounting location to the router must not exceed a maximum length of 100 m.
- A minimum distance of 1 m must be maintained from devices using the 2.4 GHz radio spectrum (e.g. WLAN devices, microwave ovens). This will prevent reduced connection quality and data transmission speed.
- The ambient conditions at the mounting location must be suitable for the operation of the Sunny Home Manager (see Section 21, page 128).

### 7.2 Mounting the Sunny Home Manager on the Top-Hat Rail

#### **⚠ QUALIFIED PERSON**

#### Requirement:

- The top-hat rail must be securely mounted in the switch cabinet.

#### Procedure:

1. Press the Sunny Home Manager with the upper retainers into the upper edge of the top-hat rail.

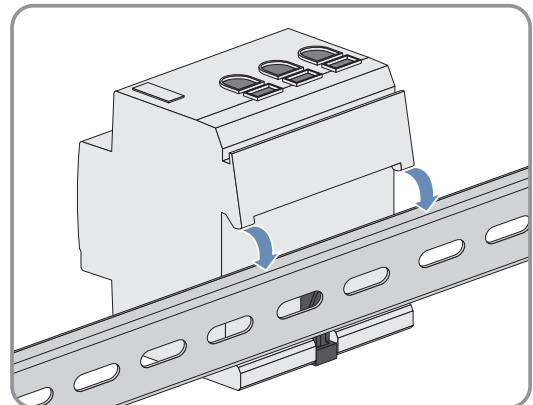

2. Hook the lower retainers into the lower edge of the top-hat rail.

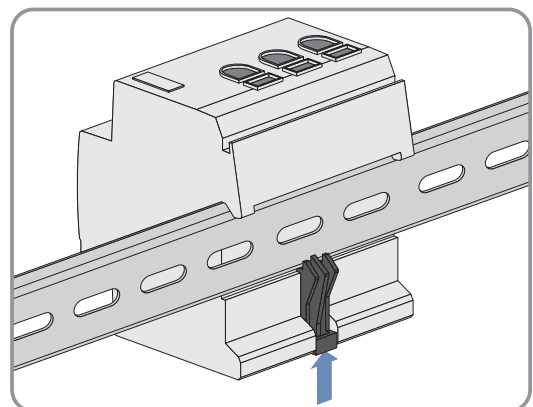



## 8 Connection

### 8.1 Safety during Electrical Connection

#### ⚠ WARNING

##### **Danger to life due to electric shock**

Under fault conditions, when working on the power supply circuit there may be dangerous voltages present on the product. This can result in death or serious injury.

- For power supply units with a fixed connection, make sure that a disconnection unit (e.g. miniature circuit breaker) is present outside the power supply unit.
- For power supply units with a plug connection, make sure that the electrical outlet for the power supply unit is close to the power supply unit.
- The disconnection unit and the electrical outlet for the power supply unit must be freely accessible at all times.

### 8.2 Connecting the Voltage Supply

#### ⚠ QUALIFIED PERSON

#### 8.2.1 Requirements for connecting the voltage supply

##### **Requirements:**

- The setpoints of the electric utility company must be observed.
- The product can be operated single-phase or three-phase. Since it is supplied with electric current by the line conductor L1, at least the line conductor L1 and the neutral conductor N must be connected in order that the Sunny Home Manager switches on.
- When using fine stranded conductors, bootlace ferrules must be used.

##### **Cable requirements:**

- Conductor cross-section without current transformer: 10 to 16 mm<sup>2</sup>
- Conductor cross-section with current transformer: see recommendations of the current transformer manufacturer

## 8.2.2 Connecting the voltage supply with energy measurements of up to max. 63 A

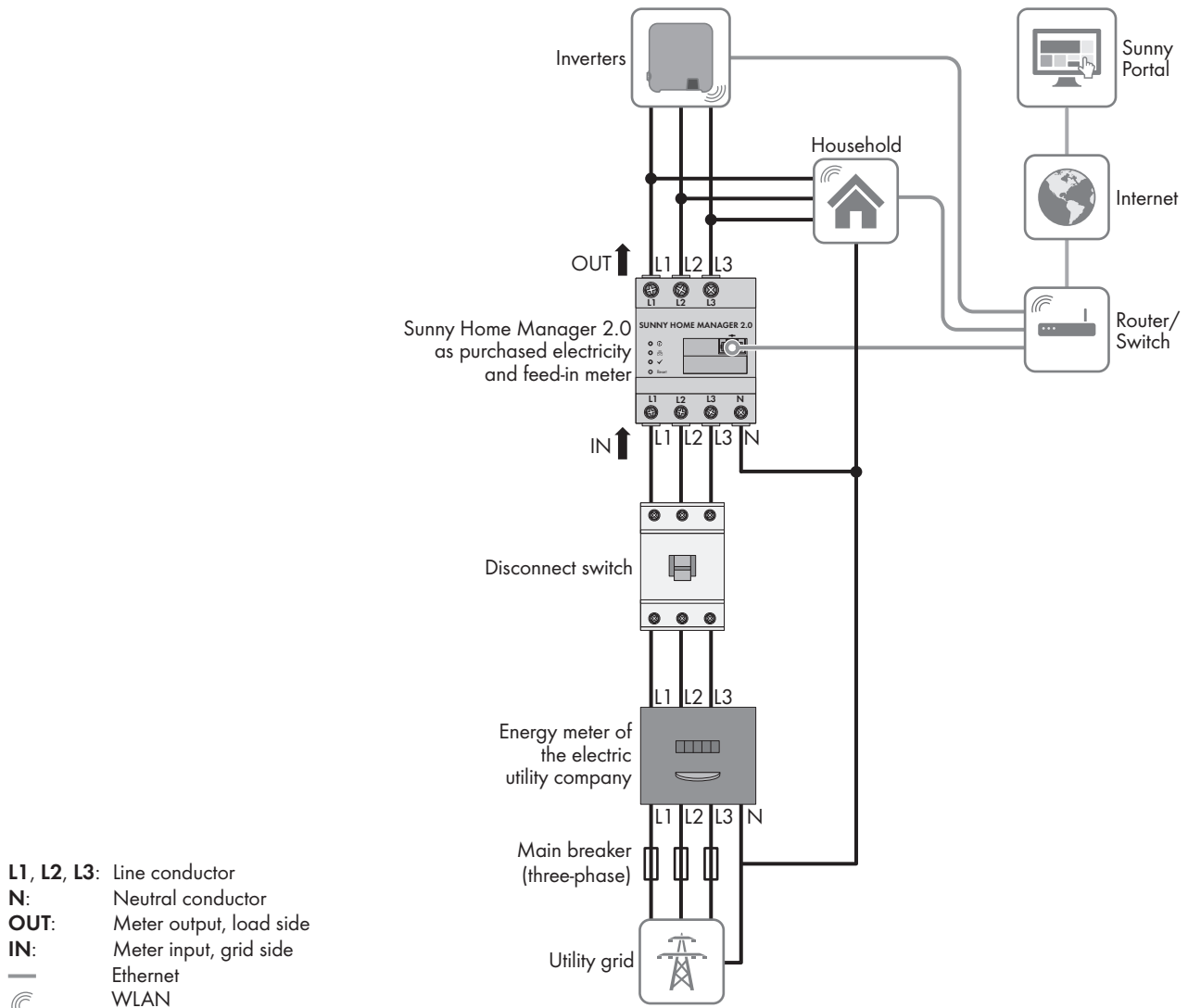

Figure 6: The following figure shows a connection example in TN and TT utility grids in the case of installation at the grid-connection point when using the integrated measuring unit.

### Procedure:

1. Disconnect the connection point from voltage sources and make sure it cannot be reconnected.
2. Connect the line conductors to the Sunny Home Manager:
  - When using the integrated measuring device
    - in **Three-phase utility grids** connect the line conductors L1, L2, L3 and the neutral conductor N to the screw terminals at the input of the Sunny Home Manager.
    - in **Single-phase utility grids** connect the line conductors L1, L2, L3 and the neutral conductor N to the screw terminals at the input of the Sunny Home Manager.
    - in **Delta IT grids** connect the line conductors L1, L2, L3 to the screw terminals at the input of the Sunny Home Manager. In addition, also connect the line conductor L3 to the neutral conductor N.

Open each screw terminal using a cross-head screwdriver, insert the conductor into the contact terminal and tighten the screw using a cross-head screwdriver (torque: 2.0 Nm).

- When not using the integrated measuring device connect the line conductor L1 and the neutral conductor to the screw terminals at the input of the Sunny Home Manager. Open each screw terminal using a cross-head screwdriver, insert the conductor into the contact terminal and tighten the screw using a cross-head screwdriver (torque: 2.0 Nm). When using the integrated measuring device of the Sunny Home Manager only for measuring the PV generation output (data logger), connect the Sunny Home Manager to the common connection point of all PV inverters in the household grid. To measure the grid exchange capacity, an SMA Energy Meter must be installed at the point of interconnection.
3. Retighten the screw terminals after six to eight weeks (torque: 2.0 Nm).

### 8.2.3 Connecting the Voltage Supply with Energy Measurements greater than 63 A

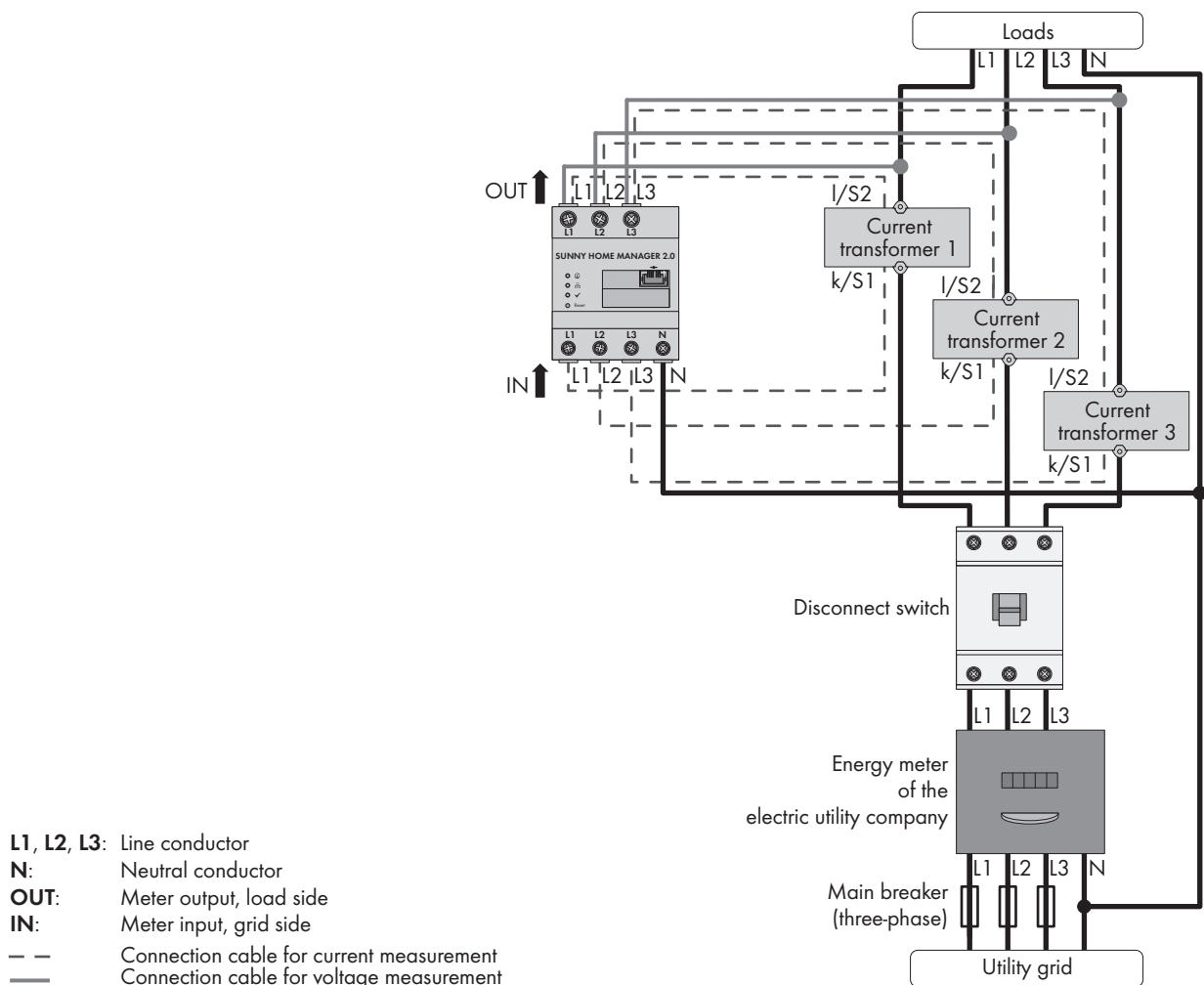

Figure 7: The following figure shows a connection example in TN and TT utility grids in the case of installation at the grid-connection point.

**For this option, additional material, not included in the scope of delivery, is required:**

- 3 x current transformer (recommendation: 5 A secondary current, accuracy class at least 1)
- Connection cables for current transformers

**Procedure:**

1. Disconnect the connection point from voltage sources and make sure it cannot be reconnected.
2. Connect one current transformer to each line conductor L1, L2 and L3.
3. On each current transformer, connect 1 connection cable for secondary current measurement to terminals k/S1 and l/S2.

4. Connect the connection cables for current measurement (dashed gray line) to the screw terminals L1, L2 and L3 of the Sunny Home Manager. To do this, open each screw terminal using a cross-head screwdriver, insert the conductor into the contact terminal and tighten the screw using a cross-head screwdriver (torque: 2.0 Nm).
5. Connect the connection cables for voltage measurement (solid gray line) to the screw terminals L1, L2 and L3 at the output of the Sunny Home Manager. To do this, open each screw terminal using a cross-head screwdriver, insert the conductor into the contact terminal and tighten the screw using a cross-head screwdriver (torque: 2.0 Nm).
6. Connect the connection cables for voltage measurement L1, L2 and L3 (solid gray line) to the corresponding line conductors L1, L2 and L3.

## 8.3 Establishing communication to Sunny Portal

### 8.3.1 Preparing for Speedwire Communication

If the Sunny Home Manager is to communicate with other SMA devices via Speedwire (Ethernet), the Sunny Home Manager and the Speedwire devices must be in the same local network. Perform the following preparatory steps.

#### **i** Inverters with Webconnect function

If an inverter is already registered in Sunny Portal with the Webconnect function, the inverter cannot be added to the Sunny Home Manager system in Sunny Portal.

- In order to be able to add the inverter to the Sunny Home Manager system in Sunny Portal, delete the inverter with Webconnect function from the Webconnect system in Sunny Portal or deactivate data reception for the inverter in the Webconnect system in Sunny Portal.

#### Requirements:

- DHCP must be active on the router (see router documentation). If your router does not support DHCP, you can configure the static network settings on the Speedwire device using SMA Connection Assist.
- All UDP ports > 1024 on the router must be open for outgoing connections. If there is a firewall installed on the router, you might have to adjust the firewall settings.
- It must be possible for the outgoing router connections to reach all Internet destinations (target IP, target port). If there is a firewall installed on the router, you might have to adjust the firewall settings.
- On the router with NAT (Network Address Translation), no port forwarding must be entered. Potential communication problems can thus be prevented.
- There must be no packet filtering or manipulation for SIP packets installed on the router.
- The routers and network switches with router function must forward the Multicast telegrams (telegrams with destination address 239.0.0.0 to 239.255.255.255) required for the Speedwire connection to all nodes of the Speedwire network.
- All network components used must support the IGMP protocol, minimum version 3 (IGMPv3) (see network component documentation).

#### Procedure:

- Connect the Speedwire devices to the router / network switch (see Speedwire device documentation). Make sure that the distance to the mounting location of the Sunny Home Manager is not too great, as the Sunny Home Manager must later be connected to the same router/network switch.

### 8.3.2 Connecting the Sunny Home Manager to the Router

Additionally required material for the connection to the local router:

- Ethernet cable (10/100 Mbit/s, RJ45 plug)

1. Connect the network cable to the network terminal of the product.  
The network cable must be suitable for connection to the product.

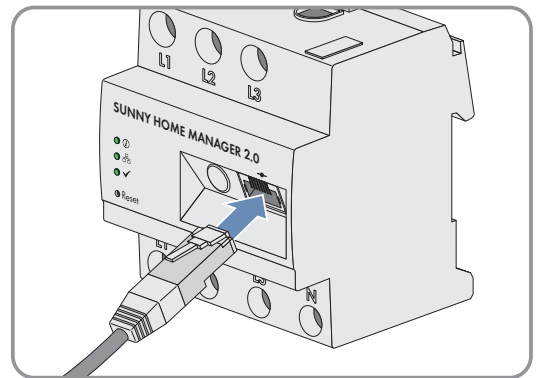

2. Connect the other end of the network cable to the router.

### 8.3.3 Testing the Connection to Sunny Portal

The Sunny Home Manager automatically establishes a connection to Sunny Portal. You can test whether there is a connection to Sunny Portal if you proceed as described in the following.

#### Requirements:

- The Sunny Home Manager must be supplied with voltage (see the installation manual of the Sunny Home Manager).
- The Sunny Home Manager must be connected to the router.
- DHCP must be active for the router (see router manual). If your router does not support DHCP, you can configure the static network settings on the Sunny Home Manager using the Sunny Home Manager Assistant (see Section 18.6.1 "Using the Sunny Home Manager Assistant in case of network problems", page 122).

#### Procedure:

1. Check whether the status LED of the Sunny Home Manager is glowing green and whether the performance LED is off.

Status display LED	Description	Further Actions
Status LED: glowing green Performance LED: off	There is a connection to Sunny Portal.	You can register the Sunny Home Manager in Sunny Portal.
Status LED: flashing red or Performance LED: flashing red	Error message: The Sunny Home Manager cannot establish the connection to Sunny Portal automatically. Possible cause: There is a proxy server in your network or your router does not support DHCP.	Use the Sunny Home Manager Assistant (see Section 18.6.1, page 122).

2. Check whether the status LED of the Sunny Home Manager is glowing green and whether the performance LED is glowing green.

Status display LED	Description	Further procedure
Status LED: glowing green Performance LED: glowing green	There is in active connection to Sunny Portal and the registration in Sunny Portal has already been executed.	Use your user data to log on to Sunny Portal (see Section 9.2, page 35).

## 9 Getting Started

### 9.1 Creating a Sunny Home Manager System in Sunny Portal

#### 9.1.1 Registering in Sunny Portal

Sunny Portal serves as the user interface of the Sunny Home Manager. Therefore, you must register the Sunny Home Manager in Sunny Portal.

An exclusively local use of the Sunny Home Manager is not intended. (Even though it would be possible after setting up the active power limitation online, it would entail significant limitations of the functions in energy management.)

**i** The system setup assistant is a step-by-step guide of the processes required for user registration and the capturing of your Sunny Home Manager system in Sunny Portal. On the right-hand side of the portal page you can find a column with detailed user information.

#### Requirements:

- The PV system and all devices in the local network must be in operation and connected to the Sunny Home Manager via a router/network switch.
- The registration ID (RID) and the identification key (PIC) of the type label of the Sunny Home Manager or of other provided labels must be available.
- The status LED must glow green and the performance LED must be off on the Sunny Home Manager.

#### Procedure:

1. Start the web browser and go to **www.SunnyPortal.com**.
2. Switch the language if necessary.  
In the website's header the default language of your web browser is specified: Click on the arrow next to the language and select the desired language from the drop-down menu.
3. Start the **System setup assistant: [Register now]**  
Alternatively, you can directly go to **www.sunnyportal.com/register**.
  - The system setup assistant opens.
4. Select **[Next]**.
  - The **User Registration** page opens.

#### Register as new user:

1. Activate the field **I am not yet registered** and select **[Next]**.
2. Enter the necessary data for registration.
3. Select **[Next]**.
  - After a few minutes you will receive an e-mail containing a link and your access data to Sunny Portal.
4. If you have not received an e-mail from Sunny Portal, check whether the e-mail has been redirected to a folder for junk mail or whether it was accidentally sent to another e-mail address.  
If this other e-mail address is an unknown address, restart the system setup assistant and register as a new user again.
5. Follow the link in the confirmation e-mail within 24 hours.
  - Sunny Portal opens a separate window to confirm successful registration.
6. Select **[Next]**.
  - The page **Select PV system** opens.

#### Log in as already registered user:

1. Select the field **I am already registered in Sunny Portal**.

2. Enter the e-mail address and the Sunny Portal password in the fields **Sunny Portal e-mail address** and **Password**.
  3. Select [**Next**].
- The page **Select PV system** opens.

### 9.1.2 Creating a new PV System

**i** Even if you already have a PV system in which you want to integrate a **Sunny Home Manager**, you have to create a new system.

In order to be able to transfer the devices of the previous "old" system to the new Sunny Home Manager system, you must first deactivate these devices (usually at least 1 inverter) in the old system. Then you can add the devices to the new system (see further below).

The procedure for later adding or replacing devices, is described in a later section (see Section 11.2.1 "Adding or Replacing Devices", page 54).

On the page **Select PV system** you can create a new PV system or select an existing system in order to replace or add devices.

**i** All devices with an identical password form a system. For this reason, a password used for all devices in a system is called a system password. The system password is the same as the device password for the user group **Installer**.

#### Requirements:

- The PV system and all devices in the local network must be in operation and connected to the Sunny Home Manager via a router/network switch.
- The Sunny Home Manager must be in operation:  
The status LED must glow green and the performance LED must be off.
- A uniform user-defined system password must be set on all Speedwire devices for the user group **Installer**. If necessary, set a uniform system password for all Speedwire devices.

#### Procedure:

1. Enable the option **Create a new PV system** and enter the required information in the text field **PV system properties**.
2. In the field **PV system name** enter a name for your system. (In this document, the PV system is called **Sunny Home Manager system**.)
3. Enter a PV system password in the **Password** field.
  - If the standard password **1111** is still set on all devices for the user group **Installer**, enter a new system password.
  - If a different uniform password has already been set on all devices, enter this password as the system password.
  - If a uniform password has not been set on all devices, set a uniform password for the user group **Installer** and enter this password in the system setup assistant as the system password.
4. Enter the system password again in the field **Repeat password**.
5. Select [**Next**].
  - The page **Select devices** opens.

### 9.1.3 Registering Sunny Home Manager and Adding Other Devices

**i** Only after the Sunny Home Manager has been registered, can other devices in the system be detected or further devices integrated.

**Procedure:**

1. On the page **Select devices** enter the identification key (PIC) and the registration ID (RID) of the Sunny Home Manager in the fields **PIC** and **RID**.  
Tip: This information can be found on the type label that is attached on the side of the Sunny Home Manager as well as on the label provided.
2. Select [**Identify**].
  - Sunny Portal searches for the Sunny Home Manager with the corresponding identification key and registration ID. The system setup assistant displays the correct Sunny Home Manager.
3. If no Sunny Home Manager with the entered PIC and RID is found, check your entries for typos and use Troubleshooting if necessary Remedial Action in Case of Problems.
4. Select [**Next**].
  - The Sunny Home Manager now searches for devices in the local network. After a maximum of ten minutes the system setup assistant lists the serial numbers of any available devices in the local network.
5. If the system setup assistant lists none or not all of the Speedwire devices of your PV system, select [**Update**]. If the problem persists, use Troubleshooting Remedial Action in Case of Problems.
6. Activate the checkboxes of the devices you wish to add to the Sunny Home Manager system.  
Tip: You can identify devices using the previously noted serial numbers.
7. If devices with a warning symbol are displayed, the Sunny Home Manager cannot access the devices. You may have entered an invalid system password or the connection to the devices could not be established Remedial Action in Case of Problems.
8. Select [**Add**] to add the devices to the Sunny Home Manager system immediately.
  - The system password is transferred to the devices. This process can take several minutes. The devices are then shown with a green tick.
9. Select [**Next**].
  - The page **Meter Configuration** opens.

**9.1.4 Configuring the Energy Meter****Requirement:**

- In order to be able to display PV generation and consumption in your household, energy meters for the measurement of the power- and energy values must be connected.
- i** The Sunny Home Manager is equipped with an internal energy meter and measures the energy flows in both directions, i.e. at the point of interconnection it measures the energy generated by the PV system (and possibly reduced by self-consumption) fed into the utility grid as well as the energy supplied by the utility grid.



**Procedure:**

1. In the area **Meter configuration** enter the desired energy meter each from the drop-down lists **Supply and feed-in** and **PV power generation**:

System Topology	Configuration
PV system with SMA inverters	<ul style="list-style-type: none"> <li>• Select the entry <b>Internal Energy Meter</b> in the <b>Purchased Electricity and Grid feed-in</b> dropdown-list.</li> <li>• Select the entry <b>No energy meter</b> in the <b>PV Generation</b> drop-down list. PV production data from the connected SMA inverters are used.</li> </ul>
PV system with third-party inverters	<ul style="list-style-type: none"> <li>• Select the entry <b>Internal Energy Meter</b> in the <b>Purchased Electricity and Grid feed-in</b> dropdown-list.</li> <li>• Select the entry <b>SMA Energy Meter xxx</b> in the <b>PV Generation</b> drop-down list. Here, <b>xxx</b> is the placeholder for the SMA Energy Meter serial number. If there are 2 SMA Energy Meters in the PV system, select the desired SMA Energy Meter. The generation power of the PV inverters is only measured via this selected energy meter. This means that any combination of PV inverters can be used.</li> </ul>

2. Select [**Next**].

The page **Extended PV System Properties** opens.

### 9.1.5 Entering the System Data

- i** When entering the data, please pay attention to the background information and the information in the column on the right **User information**.

In general, you can change your information later in Sunny Portal, i.e. adjust values and/or (de)activate functions. Detailed information on this can be found in the section on configuring the PV system (see Section 10.1, page 40).



### Extended PV System Properties

PV system power: *	<input type="text" value="0"/>	kWp
Specific Annual Yield: *	<input type="text" value="1000"/>	kWh / kWp
Zip Code/City: *	<input type="text"/>	<input type="text"/>
Country: *	United Kingdom	
Time Zone: *	(UTC+01:00) Amsterdam, Berlin, Bern, Niesle	
Feed-in Tariff: *	<input type="text" value="0,2"/>	United Kingdom Pounds (GBP) / kWh
Do you use self-generated PV energy in your household (self-consumption)? *	<input checked="" type="radio"/> Yes <input type="radio"/> No	
Self-Consumption Tariff: *	<input type="text" value="0.0000"/>	GBP / kWh
Limiting of the active power feed-in *	<input type="radio"/> no limiting of the active power feed-in <input checked="" type="radio"/> max. <input type="text" value="70"/> % of the nominal PV system power <input type="radio"/> max. <input type="text"/> kW	
Automatic updates: *	<input type="checkbox"/> Automatic update of all devices in the PV system <small>Sunny Home Manager, inverters and additional components</small>	
Sunny Places:	<input checked="" type="checkbox"/> Approve system for Sunny Places	
E-mail address of the operator:	<input type="text"/>	

\* Mandatory field

Back

Next

Figure 8: Entering the PV system data (example)

### Procedure:

- On the page **Extended PV system properties** enter your PV system data:  
You can obtain the nominal system power from your installer.  
You can obtain the specific annual yield for your system location from irradiation maps.  
The feed-in tariff is given to you by your local network provider.
- If you want to consume the energy produced by your system yourself, to switch loads for example, you have to answer the question of **Self-consumption** with **Yes**.
- Select [**Next**].  
 The system setup assistant shows a summary of your entered data.

4. Select [**Finish**].
  - Sunny Portal will confirm on the next page that your system registration was successful. A message also appears indicating that communication monitoring has been activated and that you will receive a daily report by e-mail every day.
5. To go to the Sunny Home Manager system, select [**To the PV system**].
  - The user interface of your system opens.

## 9.2 Logging In and Out of Sunny Portal

### Logging into Sunny Portal

#### Requirements:

- The Sunny Home Manager must be registered with the PV System Setup Assistant in Sunny Portal Registering in Sunny Portal.

#### Procedure:

1. Go to [www.sunnyportal.com](http://www.sunnyportal.com).
2. In the **Login** area, enter the e-mail address in the field **E-mail**.
3. Enter the Sunny Portal password in the field **Password**.
4. Activate the checkbox **Remain logged in** to stay logged in for your next Sunny Portal visits. This way, you stay logged into Sunny Portal until you log out via the user interface.
5.  **Public or shared computers**  
If you are using a public computer or are sharing yours with other people, deactivate the **Remain logged in** function. Other people could call up your data in Sunny Portal.
6. Select [**Login**].

### Logging out of Sunny Portal

When you log out of Sunny Portal user interface, your PV system will be protected against unauthorized access. The function [**Remain logged in**] is reset in this case.



Figure 9: Logging out of Sunny Portal

#### Procedure:

- Select the user name in the header of the user interface and select [**Logout**].

## 9.3 User Interface of the Sunny Home Manager System

### 9.3.1 Accessing the user interface

If you have only created one system in Sunny Portal, you will automatically access the user interface of your system after logging into Sunny Portal. If you have several systems in Sunny Portal, you will need to access the user interface of the Sunny Home Manager system after logging into Sunny Portal.

#### Procedure:

1. Log into Sunny Portal (see Section 9.2, page 35).
2. Select **PV System Selection > "Sunny Home Manager system"** in the page and menu selection.
  - The user interface of the system opens.

**i** In the **Configuration** menu under **System presentation > System home page** you can select which home page of your system you will see after login.

### 9.3.2 Overview of the User Interface

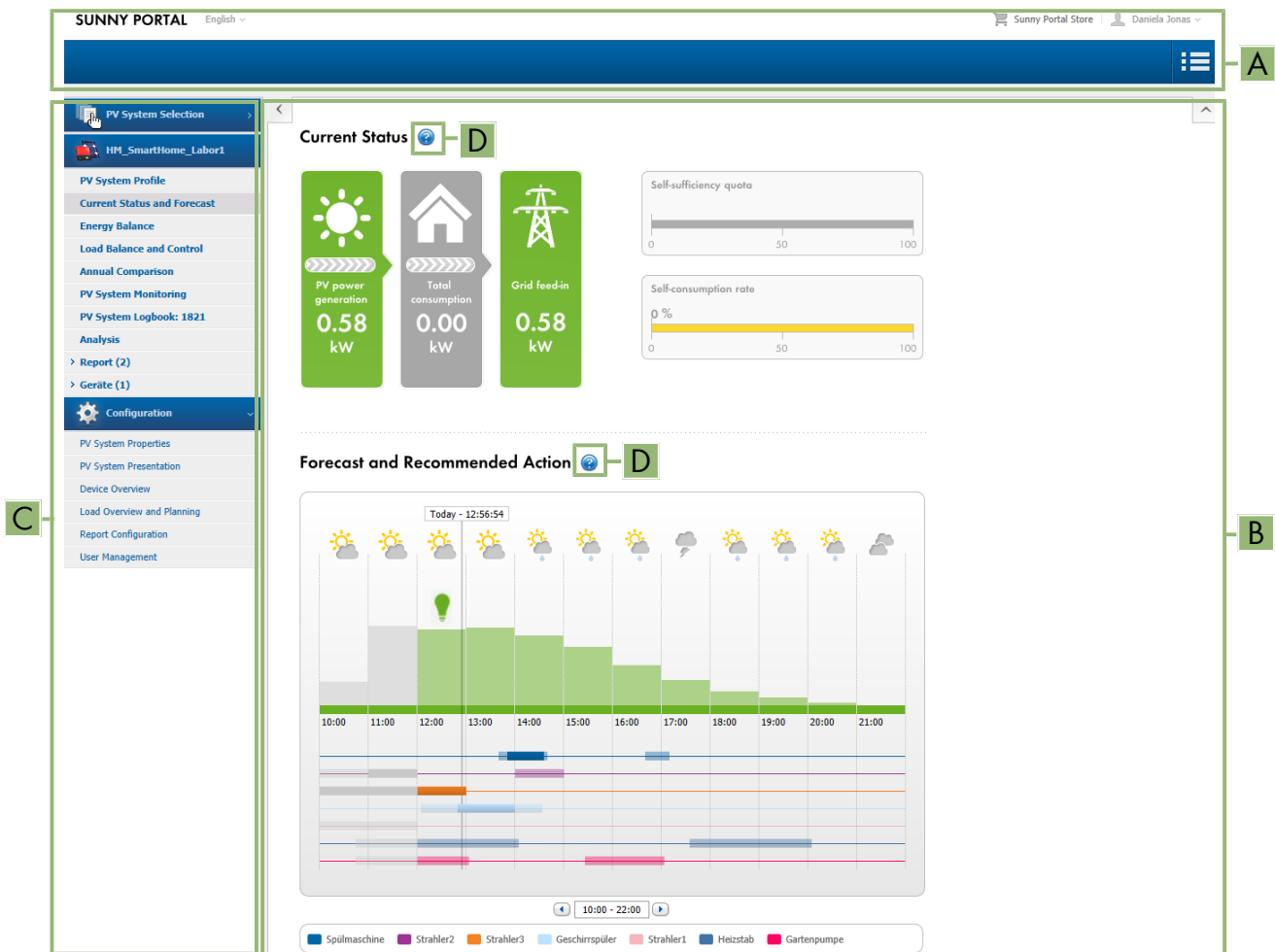

Figure 10: User interface of the Sunny Home Manager system in Sunny Portal (example)

Position	Designation	Explanation
A	Header	<ul style="list-style-type: none"> <li>Selection of the user interface language</li> <li>Logout from Sunny Portal</li> </ul>
B	Content area	<ul style="list-style-type: none"> <li>Contents of the selected page</li> </ul>
C	Page and menu selection	<ul style="list-style-type: none"> <li>Access to the various pages and menus of the Sunny Home Manager system</li> </ul>
D	Help	<ul style="list-style-type: none"> <li>Explanation of the content of the selected page</li> <li>Link to Sunny Portal help</li> </ul>

### 9.3.3 Overview of Menus and Pages

**i** Depending on your system design and the products installed in your system, you may not see all menus and pages listed here.

## System Selection Menu

The menu is only shown if your e-mail address is assigned to more than one plant. In this menu you can select the desired system. The name of the currently chosen plant will be used for the main menu item under the "Plant selection" main menu. All other pages always refer to the currently selected system.

Page	Explanation
PV System List	The page includes an overview of systems that are assigned to your e-mail address.

## "Sunny Home Manager System" menu

This menu contains all pages with information on your system, data, and visualizations for your system. You can usually adapt the visual representation of the data in the tables and diagrams shown here to your wishes and needs. You can also access the associated page from each page in the configuration menu to make changes in the configuration of your system.

Page	Explanation
System overview	This page provides you with an overview of the most important information about your system. To obtain specific information on individual data, you can switch directly from this page to the more specific pages.
System profile	This page includes an overview with information for the current plant. Sunny Portal compiles the plant profile from information that you have entered on your Sunny Portal pages. Information that you have not entered (e.g. "Operator") is not shown in the system profile.
Current Status And Forecast	This page is divided into two areas: <ul style="list-style-type: none"> <li>• The Area Current Status visualizes which portions of your household are being supplied with power from the utility grid and from your PV system respectively.</li> <li>• The area Forecast and Recommended Action gives an overview of the expected PV power as well as recommendations on the manual switching-on of loads.</li> </ul>
Energy balance	This page visualizes the temporal progression of the power or energy flowing between your PV system, your household, the utility grid and, possibly your battery.
Load balance and control	The diagrams on this page show the power and energy consumption of the loads connected.
Annual comparison	This page provides you with a summary of the total yield and the specific system yield per month in a year overview.
System Monitoring	The following functions for monitoring your system are available on this page: <ul style="list-style-type: none"> <li>• Communication monitoring: monitoring of the communication between Sunny Portal and the inverters</li> <li>• Inverter comparison: system monitoring via comparison of the inverter yields, provided that at least two inverters are present in the system</li> </ul> <p>If the communication monitoring or the inverter comparison shows an error or warning, an exclamation mark will be displayed in the page and menu selection next to the menu item System Monitoring. The icon will be displayed until communication is restored or the inverter comparison error has been eliminated.</p>

Page	Explanation
System logbook	This page shows messages in connection with the current system status. These messages help you to identify system disturbances, for example. The number of unread warning, disturbance and fault messages is indicated after the colon.
Analysis	On this page you can display the power values of individual or multiple devices and/or the overall system for the period selected with the tab. You can choose between the display types "absolute" or "specific". A summary of the current diagram data can be found under Details.
Report	The page is divided into Daily system report and Monthly system report. Depending on the selection, meter change of the total yield is displayed.
Machine	This page is divided into individual devices that are integrated in the system. In separate diagrams, for each individual device the total yield (kWh) over one year and the total yield (kW) as well as the power (kW) on a defined day is shown.

## Configuration Menu

- i** When logging in to Sunny Portal, the menu **Configuration** is collapsed by default. The main purpose of the configuration menu is the basic setup of your system and changes you want to make to general system settings and/or for the configuration of your devices. You can also carry out all configurations directly from the respective pages of the menu "Sunny Home Manager system". Refer to the User rights (see Section 16.1, page 108) to find out which individual configurations of the system you can carry out.

Page	Explanation
System properties	On this page, you can use the various tabs to configure your Sunny Portal system.
PV System Presentation	On this page there are options to release selected pages of your system for viewing, to include your system profile in your own internet presence and to specify which Sunny Portal page is to be displayed first for your PV system upon login or after switching PV systems.
Device Overview	All the devices of your system are listed on this page. You can call up device properties, parameters, and messages. Furthermore, you can search for new devices and update the list.
Load Overview and planning	On this page the loads configured with the Sunny Home Manager are shown in the load overview. Load planning shows loads for which certain time periods are configured and when these loads are to operate.
Report configuration	On this page you can configure Sunny Portal to inform you by e-mail of events and other information such as yield.
User administration	This page displays a list of all users to whom you have granted access to the system.
Sunny Portal products	This page takes you to the SMA Online Store.

- i** Most data and graphics are only fully displayed on these pages if both a feed-in meter and grid-supply meter are connected.  
The Sunny Home Manager functions both as a feed-in meter and grid-supply meter.

## 9.3.4 Display of tables and diagrams

You can display tables and diagrams and their scope differently on many pages.



For this, there are small symbols on many of the diagrams and tables:

When you move the mouse pointer over a symbol, an explanation of the meaning of the symbol is displayed with the hand symbol. Clicking on the symbol enables the underlying command.

### 9.3.4.1 Setting the Display Period

Depending on the diagram, there are different ways of setting the display period. The control element for setting the display period can be found below each diagram.





#### Procedure:

- If there is a time bar with a slider below the diagram, keeping the left mouse button pressed, click on the blue arrow and set the desired time period.
- If there is a date and arrow icons below the diagram, set the date using the arrow icons or a calendar:
  - To set the date using the arrow icons, scroll backwards using  and scroll forwards using  to select the desired date.
  - To set the date using the calendar, click on the date between the arrow icons and select the desired date.
- If there are drop-down lists between the arrow icons, select the desired time period in the drop-down lists.



### 9.3.4.2 Saving Diagram Data

You can save diagram data as csv files.

#### Procedure:

1. If you can see the gearwheel icon  on the right below the diagram, move the mouse pointer onto  and select  in the drop-down menu.
2. If there are two icons on the right below the diagram, select .
3. Click on **[Save]**.
4. Select the target directory.
5. Click on **[Save]**.

### 9.3.4.3 Printing Diagram Data

1. Move the mouse pointer onto  on the right below the diagram.
2. In the drop-down window select .
3. Select **[Print]**.
4. Select the desired printer and select **[Print]**.

## 10 Configuration of the Sunny Home Manager system

Several data of the system were already queried and entered during the registration in Sunny Portal. In the **Configuration** menu on the page **PV system properties** you can change these properties, but mainly add important details to them which enable and optimize the full functionality of your PV system in the first place.

The menu page **PV system properties** includes the following 5 tabs:

- System data
- String configuration
- Operator/installer
- Parameter
- Data release

### 10.1 System data

#### 10.1.1 System Data Overview

This tab lists general data relevant to the PV system. Some of the information is displayed on the **PV system profile** page.

##### **PV system data area**

Under **PV system data** the name of your PV system, the system identifier, the day of commissioning and the exact location are displayed. Here, you can add to or change these data that were already entered during the registration of the Sunny Home Manager system.

Furthermore, the system can be permanently deleted here.

##### **Section: Power**

The nominal PV system power is the sum of the power of all PV modules. It can be calculated automatically from the data in the device properties.

The nominal PV system power is required in order to display the following data:

- Specific system yield
- Average expected yield

##### **Description**

You can describe your system here, e.g. highlight essential features. The editor can format text, but does not support HTML. The text is also displayed on the **PV system profile** page.

##### **PV system image area**

Here can replace the standard PV system image with a user-defined system image.

The user-defined system image will also be displayed at the following locations:

- On the **PV system profile** page
- If pages have been released for Sunny Portal, the PV system image will be shown on the list of released systems on the [www.SunnyPortal.com](http://www.SunnyPortal.com) **home page**.

You can save several images in a gallery in Sunny Portal. This makes it easy to change the system image and access your images from different computers.

#### 10.1.2 Changing System Data

##### **Requirement:**

- You must have the user role **Installer** or **PV System Administrator** (see Section 16.1, page 108).



**Procedure:**

1. In the tab **PV system data**, select the button **[Edit]**.
2. Change the desired PV system data.
3. Click on **[Save]**.

### 10.1.3 Changing the System Name

Tip: A sensible name eases the differentiation between other systems in Sunny Portal.

- The system name can have a maximum of 30 characters.

### 10.1.4 Deleting the System

If you delete the Sunny Home Manager system, the system and its data will be permanently deleted.

**Requirement:**

- You must be a **system administrator** (see Section 16.1, page 108).

**Procedure:**

1. In the tab **PV system data**, select the button **[Edit]**.
2. In the **PV system data** area, select **[Irretrievably delete PV system]**.
  - A security prompt opens.
3. Select **[Yes]** to permanently delete the Sunny Home Manager system.

**i Assigning the Sunny Home Manager to another system**

To enable assignment of the Sunny Home Manager to another system, you must perform a complete reset of the Sunny Home Manager (see Section 11.6.1, page 64).

### 10.1.5 Entering the Nominal System Power

**i Nominal PV system power required for limiting active power feed-in**

You must enter the nominal PV system power correctly to ensure limitation of the active power feed-in to the correct value (see Section 10.4.2, page 44). If there are changes to the installed PV system power, you will need to adjust this value.

**Manually enter the nominal system power:**

1. In the area **Power**, enter the system power in the text field **PV system power**.
2. To set the manufacturer of the PV modules, select the manufacturer in the drop-down list **Manufacturer**.
3. To set the module types, select the module types in the drop-down list **Module type**.

**Automatic calculation of nominal PV system power****Requirement:**

- You must have entered the PV array power of all inverters Section 11.4.3, page 60.

**Procedure:**

- In the area **Power**, activate the checkbox **Calculate PV system performance from device properties**.
  - The calculated nominal PV system power is displayed.

## 10.1.6 Changing/Deleting the System Image

### Changing the System Image

#### System image requirements:

- Maximum image size: 500 kB
- Possible image formats: JPG, PNG, GIF

#### Procedure:

1. In the area **PV system image**, select [**Load image**].
2. Select the desired image from one of your directories.
3. Click on [**Open**].
4. To change the system image size, move the gray squares with the mouse.
5. To move the image section, click on the image section and move it while holding the left mouse button pressed.
6. Click on [**Save**].
7. To save an image in the gallery, upload the image to the gallery as follows:
  - [**Select from the gallery**].
  - [**Upload**].
  - [**Browse**].
  - Select the desired image from one of your directories.
  - Select [**Upload selected file**].
  - Select **×**.
    - The image is saved in the gallery.
8. To upload an image from the gallery as the system image, select [**Select from the gallery**].
9. Double-click the desired image.
10. Click on [**Save**].

### Deleting the User-Defined System Image

If you delete the user-defined system image, Sunny Portal will display the default system image (again).

#### Procedure:

1. Select [**No PV system image**] in the area **PV system image**.
2. Click on [**Save**].

## 10.2 String Configuration

A string describes a group of series-connected PV modules. Normally, a system is made up of multiple strings. Each string has specific properties, such as deviation to south (azimuth) or the roof tilt angle.

The configuration of the strings is of fundamental importance for the correct calculation of the PV forecast and thus an important prerequisite for load planning as well as the optimization of self-consumption and the self-sufficiency quota.

Further details can be found under **Adding and configuring inverters > Configure strings** (see Section 11.4.4, page 61).

## 10.3 Changing Operator Data

The contact data of the operator and the installer are listed on the tab **Operator/installer**.

The operator is a private individual or legal entity who owns PV systems for business purposes, for example. The operator can farm out use of the PV system without necessarily being the user himself.

The name of the operator is displayed on the page **PV system profile**.

**Requirement:**

- You must have the user role **Installer** or **PV System Administrator** (see Section 16.1, page 108).

**Procedure:**

1. In the tab select [**Edit**].
2. Enter the operator data.
3. Click on [**Save**].

## 10.4 Configuring parameters

This tab provides information and editing options for the following topics depending on your system design:

- Compensation
- Limitation of Active Power Feed-In
- Grid management services via Ethernet-based communication
- Electricity tariff
- Optimization target
- CO<sub>2</sub> avoided
- Expected yield
- If there is a battery inverter in the Sunny Home Manager system: Time window control for charging the battery-storage system

**The following is required for configuration within the tab Parameters:**

- You must have the user role **Installer** or **PV System Administrator** (see Section 16.1, page 108).

**i** You can find the button [**Edit**] on the very bottom of the tab **Parameters**. It applies to all parameter settings of this tab.

When selecting [**Edit**], you can change settings of different parameters and apply all changes at once with the button [**Save**].

If you do not want to apply the changes, click on [**Cancel**].

Both the buttons [**Save**] and [**Cancel**] are also on the very bottom of the tab.

Tip: Since all the changes are either applied with [**Save**] or dismissed with [**Cancel**] for the entire tab, it is recommended to save each change made on this tab separately.

### 10.4.1 Entering the Feed-In Tariff and Electricity Tariff

The values for feed-in tariff and electricity tariff were already queried and possibly entered during the system registration.

You can either use the electricity generated by your PV system for self-consumption or sell it, i.e., feed it into the utility grid. The Sunny Home Manager uses this information for cost saving and takes the entered values into account during load control to optimize self-consumption.

The entered values affect:

- Recommended actions for manually switching on loads **Current status and forecast > Forecast and recommended action**
- Load control via the Sunny Home Manager (either directly via the local network or via radio-controlled sockets)

**Procedure:**

1. Enter the feed-in tariff per kWh in the area **Reimbursement** in the text field **Feed-In Tariff**. Also select the desired currency in the accompanying drop-down list.

2. In the text field **PV system with self-consumption**, select whether self-generated PV energy is consumed in your household (self-consumption). If you select **Yes** (default setting), the self-consumption of the household is taken into consideration in the load control and recommended actions.
3. If you receive compensation for self-consumption, enter the self-consumption tariff in the text field **Self-Consumption Tariff**.
4. If you do not receive compensation for self-consumption, enter **0** in the text field **Self-Consumption Tariff**.
5. In the area **Electricity Tariff**, enter the time for which the electricity tariff applies in the input fields **From** and **To**.  
Tip: Split the night tariff into two tariffs. Configure the first tariff up to 12 midnight. Configure the second tariff from 12 midnight.
6. Enter the electricity tariff that applies to the entered time in the input field **Price**.
7. If the electricity tariff only applies to specific weekdays, activate the checkboxes with the respective weekdays.
8. If the electricity tariff applies to each weekday, activate all weekday checkboxes.
9. To enter additional electricity tariffs, select **+** and enter the data.
10. Click on **[Save]**.

## 10.4.2 Configuring Limitation of Active Power Feed-In

### Requirement:

- The parameter **Operating mode Active power** must be set to **External specification** for the inverters.

### NOTICE

#### Responsibility of the system operator for limitation of active power feed-in

The system operator is responsible for the correctness of information on limiting the active power feed-in and nominal PV system power.

- Ask your grid operator beforehand whether you are permitted to use the Sunny Home Manager to limit active power feed-in (Manufacturer's Declaration "Feed-In Management in Accordance with the Renewable Energy Sources Act (EEG) 2012 with Sunny Home Manager (SHM) from SMA" available at [www.SMA-Solar.com](http://www.SMA-Solar.com)).
- Set the limitation of active power feed-in required by the grid operator. If you are not sure about this, contact your grid operator.
- Ensure you have correct information on the nominal PV system power. If you extend the system, adjust the value for the nominal PV system power accordingly.

-  Ensure that your feed-in meter complies with the requirements (see the installation manual of the Sunny Home Manager and the planning guidelines for SMA Smart Home).

The Sunny Home Manager avoids derating losses due to limitation of PV power generation by taking the current self-consumption of the household into account and by increasing the self-consumption quota through direct use of the generated PV power for PV systems with self-consumption. For PV systems with SMA battery inverters, the Sunny Home Manager preferentially uses the derated active power to charge the battery.



### Limitation of the active power feed-in to 70% of the nominal PV system power

Due to high levels of solar irradiation, the system can currently produce 90% of the nominal PV system power.

- 20% of the nominal PV system power is currently being consumed by loads in the household. The remaining amount of 70% of the nominal PV system power is being fed into the utility grid.
  - No limitation of PV generation is required.
- A load is switched off and only 10% of the nominal PV system power is consumed in the household. As a result, 80% of the nominal system power is available for feed-in to the utility grid – more than allowed.
  - The Sunny Home Manager reduces PV generation from the theoretically possible 90% of nominal PV system power to 80%. 70% of the nominal PV system power continues to be fed into the utility grid.

### **i** Supported inverters for the limitation of the active power feed-in to 0%

Limitation of the active power feed-in to 0% is only supported by inverters that support the fallback function (fallback: in the event of a communication failure between the Sunny Home Manager and the inverter, the inverter reverts to an output power of 0 watts). For more information see the inverter manual at [www.SMA-Solar.com](http://www.SMA-Solar.com).

If your grid operator only allows a certain active power feed-in into the utility grid, the Sunny Home Manager can monitor and fulfill this requirement by limiting the PV generation of the inverters when the specified limit is exceeded. This takes into account that in times when your PV system generates a lot of PV power, which is also used directly by loads - household appliances or a battery that is being charged - a PV power higher than the feed-in limitation is allowed regardless (dynamic active power limitation).

In addition to the dynamic limitation of PV generation, the Sunny Home Manager can also use intelligent energy management to ensure that loads in the household are switched on at precisely those times when so much PV energy is available that the feed-in limit would be reached. If switching on a load means that more power is consumed directly in the household, then the PV generation must not be reduced by as much or must not be reduced at all.

- Limitation to a fixed value in kW
- Limitation to a percentage of the nominal system power (setting range: 0% to 99%)
- Zero feed-in or zero export (avoids feeding into the utility grid) (setting: 0% of the nominal PV system power)  
Despite zero export, an inevitable remaining quantity of energy might be fed into the utility grid due to control cycle times.

If a battery inverter is part of your PV system, entering a minimum reaction time becomes possible starting with a limitation set at < 10% of the nominal PV system power. After grid feed-in has occurred, the battery inverter will thus be given enough time to use the feed-in power to charge the battery-storage system.

Typical reaction times for SMA battery inverters: The default value of 5 seconds ensures the inclusion of the usual battery-storage systems (for specific values see documentation of the battery-storage systems).

#### Procedure:

1. In the area **Limiting of the active power feed-in**, select the applicable option:
  - If limitation of active power feed-in is not required for your system, select **no limiting of the active power feed-in** (default setting).
  - If limitation of active power feed-in is required for your system, carry out the following steps:
    - To test whether the limitation of active power feed-in is working in the system, select the option **max. xx kW** and enter the value **0**. Thus, the Sunny Home Manager immediately limits the active power when the inverters start feeding into the utility grid.

- If the grid operator requires limitation to a percentage of the nominal PV system power, select the option **Max. xx % of the nominal PV system power** and enter the required percentage.
  - If the grid operator requires limitation of the active power feed-in to 0%, select the option **Max. xx% of nominal PV system power** and enter the value **0**.
  - If the grid operator requires limitation to a maximum active power in kW, select the option **max. xx kW** and enter the maximum permitted active power in kW.
2. Click on [**Save**].
    - The data is being transferred. This can take up to 5 minutes.
  3. To display the active power limitation, select **Energy balance > Day** in the page and menu selection.
    - In the diagram **Generation** the specified limitation of active power feed-in is displayed as a dotted red line.

### 10.4.3 Activating/Deactivating Grid Management Services

As part of grid management services, it may be necessary to implement grid operator specifications for active power limitation and for reactive power feed-in (e.g. the active power feed-in of your PV system will be reduced in the event of grid overloads). The Sunny Home Manager can receive these specifications via Ethernet-based communication. The grid operator can set up this link. For this, you have to activate grid management services for the Sunny Home Manager.

#### Procedure:

1. Select the appropriate option in the area **Grid management services via Ethernet based communication**:
  - If the Sunny Home Manager does not have to implement any grid operator specifications, select **No** (default setting).
  - If the Sunny Home Manager has to implement any grid operator specifications, select **Yes**.  
The default setting Port **502** can normally remain set.
2. Change the port if necessary:
 

If there are several Modbus devices in the network or if the grid operator specifications are to be transmitted via a certain port, enter this port in **Port xxx**.

If you change this port, you must also change it in your VPN router and inform the grid operator of this change.
3. Click on [**Save**].
  - The data is being transferred. This can take up to 5 minutes.

### 10.4.4 Entering time period control for charging the battery-storage system

The time period control is only available for systems with Sunny Island or Sunny Boy Storage.

It might make sense to charge battery-storage systems at defined times (typically at low tariffs at night) due to time-dependent electricity tariffs from the electric utility company.

The time period control for battery charging competes with the regular control of a battery inverter. As soon as a time frame for battery charging has been defined, the values self-consumption/self-consumption rate and self-sufficiency/self-sufficiency quota are therefore hidden in the energy balance of the system. Reason: Due to set specifications of the battery charging power and time periods, it is likely that energy from the utility grid is also used for charging the battery. This can distort the above-mentioned values significantly and permanently. Should all time frames be removed at a later time, incorrect values might then be displayed.

Please refer to the SMA documentation for the system design and dimensioning.

#### Procedure:

1. In the **Time period** area click on .
2. Enter time interval (in 15 minute steps).
3. Select day(s) that should apply to this time interval.

4. Enter the charging power (W).
5. To enter another time period, click on **+** again and repeat the procedure.
6. You can undo unwanted entries with **-**.
7. Confirm all your entries with [**Save**].

**i** You can specify time periods for several days as well as several consecutive time periods within a specific day.

### 10.4.5 Setting the Optimization Target

The optimization target indicates whether the Sunny Home Manager should prioritize ecological or economical factors during load management:

- **ecological:** highest possible self-consumption  
Greater self-consumption conserves the environment because there is no energy loss caused by the transport of current through the utility grid.
- **economical:** highest possible cost savings  
The Sunny Home Manager calculates the most financially rewarding control of the loads, taking into consideration the feed-in and self-consumption tariffs. In certain cases, it may be more economical to feed the PV electricity into the utility grid and to operate the individual loads at night using electricity purchased from the grid.

The optimization target affects the following components:

- Load control via the Sunny Home Manager (either directly via the local network or via radio-controlled sockets)
- Recommended actions in the diagram **Forecast and Recommended Action** on the page **Current Status and Forecast**

#### Requirement:

- The feed-in tariff, self-consumption tariff and electricity tariff must be entered (see Section 10.4.1, page 43).

#### Procedure:

1. In the area **Optimization Target**, click the slider and, holding the left mouse button pressed, set the optimization target:
  - To achieve the highest self-consumption possible, move the slider towards **ecological**.
  - To achieve the greatest possible cost savings, move the slider towards **economical**.
2. Click on [**Save**].

### 10.4.6 Entering the Amount of CO<sub>2</sub> Avoided

The CO<sub>2</sub> factor indicates how much CO<sub>2</sub> is produced for one kilowatt hour of electric current generated in the country. Depending on the technology used and the efficiency, the CO<sub>2</sub> factor can vary between the different electric utility companies in the region. You can find out the value of the CO<sub>2</sub> factor of the electric current supplied in your region from your electric utility company.

Sunny Portal can use the CO<sub>2</sub> factor to calculate how much CO<sub>2</sub> was saved due to the power generation of your system.

You can view the value of CO<sub>2</sub> avoided on the following pages:

- System profile
- Report configuration

#### Procedure:

1. In the area **Factor**, enter the CO<sub>2</sub> factor in the text field or click the slider and, holding the left mouse button pressed, set the CO<sub>2</sub> factor.
2. Click on [**Save**].

## 10.4.7 Entering the Expected Yield

### Entering the Predicted Annual Yield

Sunny Portal can display in a table how the predicted annual yield of your system is likely to be distributed throughout the months of the year.

The predicted annual yield of the system is calculated from the specific annual yield (kWh/kWp) at the system location multiplied by the nominal PV system power (kWp).

You can obtain the specific annual yield for your system location from irradiation maps. Local conditions such as the shading or orientation of the system are not taken into account by Sunny Portal. You can obtain the nominal system power (also called nominal power) from your installer.

#### Requirements:

- The nominal PV system power must be set (see Section 11.4.3, page 60).

#### Procedure:

1. In the area **Yield Expectations**, enter the specific annual yield in the text field **Specific Annual Yield**.
2. To enable configuration of the average expected yield and the monthly distribution on the page **Annual Comparison**, activate the checkbox **The monthly distribution can be configured in the diagrams**.
3. Click on **[Save]**.

### Entering the monthly distribution of the predicted annual yield

The monthly distribution shows how the predicted annual yield is likely to be distributed throughout the months of the year.

You have the following options:

- Having Sunny Portal Suggest the Monthly Distribution
- Entering the monthly distribution manually

#### Requirement:

- The system location must be entered (see Section 10.1.2, page 40).

### Having Sunny Portal Suggest the Monthly Distribution

#### Procedure:

1. In the area **Yield expectations**, select **[Suggest a Monthly Distribution]**.
  - The monthly distribution is displayed in the table with the months.
2. To display the average expected yield and the monthly distribution in the diagrams on the pages **Annual Comparison** and **Energy and Power**, activate the checkbox **Display the monthly distribution in the yearly comparison, as well as energy and power**.
3. To enable configuration of the average expected yield on the pages **Annual Comparison** and **Energy and Power**, activate the checkbox **The monthly distribution can be configured in the diagrams**.
4. Click on **[Save]**.

### Entering the monthly distribution manually

Enter the percentage distribution of the expected annual year. You can change these values at any time to get a better distribution.

#### Procedure:

1. In the area **Yield Expectations**, enter the values in the text fields **in %** in the table with the months. The sum must add up to 100%.



2. To display the predicted annual yield and the monthly distribution in the diagrams on the pages **Annual Comparison** and **Energy and Power**, activate the checkbox **Display the monthly distribution in the yearly comparison, as well as energy and power**.
3. To enable configuration of the predicted annual yield on the pages **Annual Comparison** and **Energy and Power**, activate the checkbox **The monthly distribution can be configured in the diagrams**.
4. Click on **[Save]**.

## 10.5 Releasing Data

SMA Solar Technology AG/SMA takes the protection of your data very seriously. This applies to personal and system-related data. We guarantee that your data will be treated confidentially and will not be used by SMA or third parties for any other purpose without your explicit agreement. You can specify here to what extent SMA or third parties may use your data. You can withdraw your consent to the use of your data at any time with effect for the future.

You can set whether to make your PV system data available to the internet portal Sunny Places and/or participate in the program SolarCoin.

**Sunny Places** is an Internet portal for private PV system owners where you can publicly present your PV system in addition to Sunny Portal, compare your PV system with other registered PV systems, and exchange experiences with other PV system owners. Sunny Places is free of charge.

**SolarCoin** is a reward system for producers of solar energy. The SolarCoin Foundation gives energy producers blockchain based digital tokens worth a SolarCoin (SLR) for each megawatt hour (MWh) of produced solar energy. SolarCoin is free of charge. Everyone who produces solar energy can receive SolarCoin. SolarCoin is global, decentralized and independent of each government. The sales part of the project is designed for a term of 40 years. SolarCoin can be spent and traded like a crypto currency, but focuses on promoting environmental activities in the real world: verifiably generated solar energy.

The mission of the **SolarCoin Foundation** is to accelerate the global energy transition by rewarding solar producers with the first energy-referenced currency. As an additional incentive for PV system owners, SolarCoin has become increasingly prevalent within the industry. The SolarCoin Foundation rewards solar power generation by issuing blockchain-based digital tokens. One SolarCoin (SLR) is issued for each megawatt hour (MWh) of power generated. SolarCoins constitute a monetary value and, as a solar currency, reduce the financing costs in the solar industry worldwide.

### Agreement of data use via Sunny Places:

Your agreement includes that Sunny Places may regularly call up the system name and energy yields of your system via Sunny Portal. Thus, you have the possibility of also using the Sunny Places services alongside Sunny Portal without any extra costs. Your PV system data will only be displayed in Sunny Places once you register in Sunny Places and connect with your PV system there. In Sunny Places, you also have the option of defining how much of the PV system data or of your profile will be published by making the appropriate settings.

### Consent to participate in the SolarCoin program:

With your consent you allow your PV system to participate in the SolarCoin program. Yield data are transmitted to solarcoin.org and, if available, credited to your wallet.

- The system location must be entered Changing System Data.

# 11 Device Administration

In the menu **Configuration > Device overview** you can configure and add devices to your Home Manager system as well as replace. You also obtain information on all the devices in your system.

## 11.1 Device Overview Tab

This tab displays information on all the products that have already been configured in your PV system.

**i** If new devices were detected in the system, this is shown to you in the tab **Device overview**. By clicking on **Set up devices now** you are redirected to the tab **Overview of new devices**.

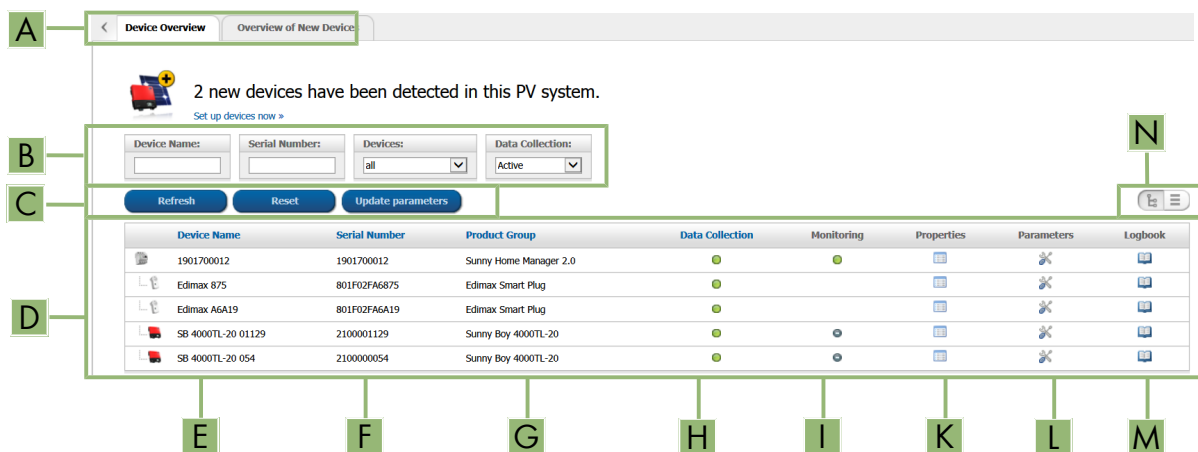



Figure 11: Device overview tab (example of new devices having been detected.)

Position	Designation	Explanation
A	Tabs of this menu page	<b>Device overview</b> tab is active.
B	Filters	Text fields and drop-down lists for filtering the device overview
C	Buttons	These buttons refer to the filters (B): <ul style="list-style-type: none"> <li>• <b>Update</b> or <b>Reset</b> - refers to the previously set filter</li> <li>• <b>Update parameters</b> - updates the parameters of all devices</li> </ul>
D	Device List	–
E	Device Name	Device name
F	Serial Number	Serial number of the device
G	Product group	Product group of the device, e.g. Sunny Home Manager 2.0, Sunny Boy 4.0 1AV-41
H	Data collection	Displays whether the data of this device is to be used on your Sunny Portal pages (●).
I	Monitoring	Displays whether the communication monitoring or the inverter comparison is activated (●) on the devices.
K	Characteristics	Opens the tab <b>Device: xxx</b> with information on the device each selected. Depending on the device and the device settings, various device properties can be displayed on the tab of the device.  You can make settings on the devices using the <b>Properties</b> tab.

Position	Designation	Explanation
L	Parameter	Opens the <b>Parameters</b> tab with the parameters of each the selected device. You can read off the software package version in the parameter list. The parameters of a device are described in the respective device manual. The device parameters on this page can only be read but not changed. However, you can have previous changes displayed in the column History  .
M	Logbook	Opens the <b>System logbook</b> tab with the messages for this device.
N	Table display	Device display in hierarchal tree structure or as simple list

### 11.1.1 Filtering the Device Overview

You can find individual devices more easily if you filter the device overview. You have the following options for this:

Text field or drop-down list	Explanation
Device name	Complete name of the device or parts of the device name
Serial Number	Complete device serial number or parts of the serial number
Machine	Device class sought, e.g. <b>Sunny Home Manager, Radio-controlled socket, Photovoltaic inverter, Battery inverter</b>
Data collection	<ul style="list-style-type: none"> <li>• <b>All</b>: both activated and deactivated devices are shown.</li> <li>• <b>Active</b>: only activated devices are shown.</li> <li>• <b>Deactivated</b>: only deactivated devices are shown.</li> </ul>

#### Procedure:

1. Set one or more filters.
2. Select [**Refresh**].  
Tip: In the list view  you can sort the devices in the device overview in ascending or descending order by clicking the blue entries in the table header.
3. To clear the filter, select [**Reset**].

### 11.1.2 Configuring the Device Properties

On the page **Device overview** you can view the **Properties**  for each listed device - and depending on the user right - verify and change the current configuration of a device.

#### Requirement:

- You must have the user role **Installer** or **PV System Administrator** (see Section 16.1, page 108).

 Depending on the **Device class**, various device properties are displayed. Only the device properties area is available for all device classes.

Device class	Information that can be edited
Sunny Home Manager	<p>The Sunny Home Manager organizes the system and controls all devices installed in the system.</p> <ul style="list-style-type: none"> <li>• Device properties: <ul style="list-style-type: none"> <li>- Device Name</li> <li>- Description</li> <li>- Data request interval (extended configuration)</li> <li>- Time Zone</li> <li>- System password</li> <li>- Automatic updates</li> </ul> </li> <li>• SMA SMART HOME settings (extended configuration)</li> <li>• AVM FRITZ!Box Smart Home control</li> <li>• Edimax Smart Plug Settings</li> <li>• External current transformer (extended configuration)</li> <li>• System communication monitoring</li> <li>• Energy meter configuration (extended configuration)</li> </ul>
Inverters	<ul style="list-style-type: none"> <li>• Device properties: <ul style="list-style-type: none"> <li>- Data collection</li> <li>- Device Name</li> <li>- Description</li> <li>- Phase</li> </ul> </li> <li>• SMA Smart Connected</li> </ul> <p>The following settings can only be made for <b>Photovoltaic</b> inverters:</p> <ul style="list-style-type: none"> <li>• PV array power</li> <li>• Add string</li> <li>• Inverter comparison <ul style="list-style-type: none"> <li>- Monitoring</li> <li>- Tolerance</li> </ul> </li> </ul>
SMA radio-controlled socket	<ul style="list-style-type: none"> <li>• Device properties: <ul style="list-style-type: none"> <li>- Data collection</li> <li>- Device Name</li> <li>- Description</li> <li>- Loads (e.g. washing machine)</li> </ul> </li> </ul>

### 11.1.3 Changing Device Names and Description

#### Changing Device Names

The serial number of the device is displayed as the default device name.

**Procedure:**

1. In the text field **Device name** enter a device name.  
The maximum length of the device name may be 20 characters.
2. Click on [**Save**].

**Entering or changing the description of a device**

You can enter an user-defined description for each device. The description of the device is displayed in **Device Properties**.

**Procedure:**

1. Enter a description in the text field **Description**.
2. Click on [**Save**].

**11.1.4 Activating/Deactivating Data Collection**

You can set whether or not Sunny Portal should accept and display data of the devices integrated in the system (e.g. inverters, radio-controlled sockets, smart loads).

Only if you enable the data collection for a device, can Sunny Home Manager capture and use the data of this device for monitoring, forecast and control.

**Requirement:**

- You must have the user role **Installer** or **PV System Administrator** (see Section 16.1, page 108).

 The device must not be the Sunny Home Manager.

You must **Activate** data collection:

- for **Inverters:**  
if you want to monitor the power of an inverter (and thus the system) and/or compare yields of different inverters to each other
- for **Radio-controlled sockets:**  
if you would like to control the loads via the radio-controlled socket
- for **Smart appliances:**  
if you would like to control these loads directly via the interface included in the device

If you deactivate data collection, no data of the deactivated device can displayed in Sunny Portal. No monitoring or load control is possible then, for example.

In the following cases, you must **deactivate** the data collection of a device in Sunny Portal:

- You no longer wish to display the device in Sunny Portal  
**or**
- You have removed the device from your PV system  
**or**
- You would like to replace the device in Sunny Portal by another device.

The data of the deactivated device is retained in Sunny Portal and remains visible on the menu page **Evaluation**.

**Procedure:**

1. Call up the device **properties** of the required device in the menu **Device overview**.
2. Select [**Edit**].
3. Place a checkmark in the field **Active** under **Data collection** to activate data collection.
4. Remove the checkmark in the field **Active** under **Data collection** to deactivate data collection.
5. Click on [**Save**].

**i** If data collection has been **Deactivated** for a device, the device is not listed in the device overview (see Section 11.1, page 50) with the filter setting **Active** (see Section 11.1.1, page 51).

## 11.2 Overview of New Devices Tab

Via this tab, you can add new devices to the system or replace devices using the configuration wizard.

**Device Overview** | **Overview of New Devices**

**A new device has been detected in this PV system.**

With which configuration would you like to add the new device to this Sunny Portal PV system?

- +** **As a PV System Extension (Additional Device)**  
(configuration assistant opens)
  - Edit the device name
  - Adjust generator power
- ↔** **As a Replacement Device**  
(configuration assistant opens)
  - Before starting the configuration wizard, you must deactivate the data acceptance of the device to be replaced.
  - Select the device to be replaced
  - Transfer data to the replacement device

**Important Information:** Incorrect allocation of new devices may lead to faulty display.

Device	Product Group	Serial Number	Configuration
	Edimax Smart Plug		

**Refresh devices**

Figure 12: Tab new devices - a radio-controlled socket was added to the system in the example

There are the following configuration options for new devices:

- Configure the device as a system extension
- Configure the device as a replacement device

The configuration wizard guides you through the individual steps. Various information is queried depending on the device type.

### 11.2.1 Adding or Replacing Devices

**i** **You have to capture the new device with the Sunny Home Manager.**

The Sunny Home Manager uses the system password to log in to the devices of the system. If new devices (inverters, batteries, etc.) are to be added to the system, the Home Manager must also log in there. For this, the default password 1111 (factory-preset) or the system password must be set for these devices. The Sunny Home Manager then first tries to log in to the new devices with the system password. If this fails, the Sunny Home Manager repeats the process with the preset default password 1111.

#### Requirements:

- The new device must be in operation.
- You must have the user role **Installer** or **PV System Administrator** (see Section 16.1, page 108).
- For the new SMA device, the default password **1111** for the user group **Installer** or the system password of the existing system must be set (see Section 17.3, page 112).
- When adding AVM radio-controlled sockets, the AVM FRITZ!Box Smart Home control must first be set up (see Section 11.3.3, page 56).

**i** If you need to replace the Sunny Home Manager, you must use the system setup assistant (see Section 9.1.1, page 30).

**i** **A device can only be assigned to ONE Sunny Portal system.**

To use a device that has already been used in another system, it must be deactivated in the old system.

**i** **Device replacement: The old device must NOT be deleted, but deactivated**

If you delete the device that you wish to replace from Sunny Portal, all the device data is irretrievably deleted.

- To retain the data of the old device in Sunny Portal, do not delete the old device, but deactivate it.
- Add the new device as an additional device to the Sunny Home Manager system (replacement device).
- If the Sunny Home Manager is to be replaced, the old device must be deleted from the system; deactivation is not possible.

**i** **Smart appliances cannot be replaced**

Smart appliances which communicate via a data exchange protocol with the Sunny Home Manager cannot be replaced in Sunny Portal.

- To retain the data of the old load in Sunny Portal, do **not** delete the old load, but deactivate it (see Section 11.1.4, page 53).
- Add the new load as an additional device to the Sunny Home Manager system (system extension).

**Procedure:**

1. Select **Device overview > Overview of new devices** in the page and menu selection.
2. Select [**Refresh devices**]. The Sunny Home Manager then searches for new devices in the local network.
  - After a maximum of one minute, all new devices are displayed.
3. If none or not all of the new devices are displayed, there is an error that must first be rectified (see Section 18, page 114).
4. To add a device, select **+** in the line of the device.
5. To replace a device, select **⊞** in the line of the new device.
  - The Sunny Home Manager connects to the new device. Page 2 of the configuration wizard opens.
6. If page 2 of the configuration wizard does not open, but the error message **Connection failed** is displayed, there is an error that must first be rectified (see Section 18, page 114). A password other than the standard password 1111 or than the system password of the existing system may have been set for the new device. In this case, temporarily change the system password of the existing system to the password of the new SMA device (see Section 17.3, page 112).
7. Follow the instructions of the configuration wizard.
  - The new SMA device is displayed under **Configuration > Device overview**.
  - The new device connected via Ethernet is displayed under **Configuration > Load overview and planning**.
8. If you have just changed the system password of the existing system to the password of the new SMA device, reset the old system password (see Section 17.3, page 112).
9. If the new device is a radio-controlled socket, configure the radio-controlled socket.

## 11.3 Configuring the Sunny Home Manager

**Requirement:**

- You must have the user role **Installer** or **PV System Administrator** (see Section 16.1, page 108).

### 11.3.1 Simple or Extended Configuration

When calling up the **Device properties** of the Home Manager the **Simple configuration** is shown. Here, you can make default settings.

Only after you have selected [**Edit**], is the option **Extended configuration** provided for selection. Here you can make settings that are usually only required when first configuring the Home Manager.

#### Selection of view:

1. Call up the **Properties** of the Home Manager under **Device overview**.
  - View:** Simple configuration
2. Select [**Edit**].
  - In the **View:** line both options are now shown: **Simple configuration** (activated) and **Extended configuration**.
3. If you want to configure further functions, select **Extended configuration**.
  - The tab page opens and displays additional setting options.
4. Make the required settings and confirm with [**Save**].

### 11.3.2 Setting Automatic Updates

If the automatic software update is activated, Sunny Portal regularly checks whether there are update files for the Sunny Home Manager or for the PV system devices. If there are update files, these are automatically downloaded and the devices are updated.

You can activate/deactivate the automatic software update for:

- Sunny Home Manager
- PV system devices

By default, the automatic software update is activated for the Sunny Home Manager and the devices in the PV system.

### 11.3.3 Configuring AVM FRITZ!Box Smart Home Control

The Sunny Home Manager does not communicate directly with the AVM radio-controlled sockets FRITZ!DECT 200 (for indoors) and FRITZ!DECT 210 (for outdoors). Communication takes place indirectly via the FRITZ!Box.

#### Requirements:

- You must have a FRITZ!Box with Smart Home software support.
- The radio-controlled sockets connected to the FRITZ!Box must have been correctly connected and commissioned (see manufacturer's manual).
- The radio-controlled sockets connected to the FRITZ!Box must be able to measure the energy consumption.
- FRITZ!Box with DECT function for e.g. FRITZ!DECT 200 or FRITZ!DECT 210 must be available.

#### Procedure:

1. In the menu **Configuration** select the **Device overview**.
2. Select **Properties** in the row of the Sunny Home Manager.
3. Select [**Edit**].
4. Go to **AVM FRITZ!Box Smart Home control** and select **Yes** under **FRITZ!Box Smart Home available**.
  - Further setting options open up.
5. Under **FRITZ!Box login to home network**, select the login type which is set for the FRITZ!Box from the drop-down list.



6.  By default, the FRITZ!Box uses the **FRITZ!Box password** for login. If the login type in the FRITZ!Box has been changed, it can be viewed in the FRITZ!Box settings in the FRITZ!Box user interface under System > FRITZ!Box users > Login to the home network.  
If a user was created in the FRITZ!Box for controlling the AVM radio-controlled sockets by the Sunny Home Manager, the setting **FRITZ!Box user and password** must be selected both in the FRITZ!Box and here.  
Make sure that the settings for the FRITZ!Box login in the home network are the same in the FRITZ!Box and in the Sunny Home Manager.
  7. Under **FRITZ!Box address** keep the default setting ("fritz.box" by default), the IP address of the FRITZ!Box or the IP address under which the user interface of your FRITZ!Box in your home network can be reached.
  8. If you set up a password query for logging in to your FRITZ!Box, you must enter and repeat this password under **FRITZ!Box password**. (Otherwise, this step is not necessary.)
  9. Click on [**Save**].
- After a few minutes, the AVM radio-controlled sockets appear in the **Overview of new devices** and can now be configured.

### 11.3.4 Setting the Edimax Smart Plug

Now the password for the Edimax radio-controlled sockets can be entered in the device properties of the Sunny Home Manager:

- Enter the Edimax password.

-  All Edimax smart plug outlets in the system must have the same password. Otherwise the Edimax smart plug outlets may not be controlled by the Sunny Home Manager.  
Ensure that the shared password is also entered in the Edimax app for each outlet.

### 11.3.5 Enabling System Communication Monitoring

In the area **System communication monitoring** you can only deactivate or activate monitoring of your system. In the other fields the current configuration of the communication monitoring is displayed.

You can make changes to this configuration in the main menu of your system on the page **PV system monitoring** as follows:

1. Click on the button [**Settings**].
  - The tab **Configuration communication monitoring** opens.
2. Set the desired option (off / liberal / tolerant / sharp) using the slider under **Alerts**.
  - Under **Time** the associated time period is displayed after which an alarm may be issued.
3. Click on [**Save**].

### 11.3.6 Setting the Data Request Interval

The data request interval defines how often the Sunny Home Manager sends data to and requests data from Sunny Portal.

- Setting only possible under **Extended configuration**.

**Procedure:**

1. In the area **Data request interval** , select the desired option:

Option	Description
automatically	The Sunny Home Manager updates data on the pages <b>Current Status and Forecast</b> and on the tabs <b>Current</b> within a few seconds. The Sunny Home Manager sends data that is displayed on other pages to Sunny Portal within a few minutes (up to a maximum of 15 minutes).  Sunny Portal can only display current Sunny Home Manager data and switch radio-controlled sockets if the data request interval is set to <b>Automatic</b> .
Hourly	The Sunny Home Manager sends data to and requests data from Sunny Portal hourly. Settings made via Sunny Portal are sent to the Sunny Home Manager within 60 minutes.
Daily	The Sunny Home Manager sends data to and requests data from Sunny Portal every 24 hours. Settings made on Sunny Portal are sent to the Sunny Home Manager within 24 hours.

2. Click on [**Save**].

 If loads are controlled via radio-controlled sockets, you must activate the **Automatic** option.

SMA Solar Technology AG only recommends setting the data request interval to **Hourly** or **Daily** if your Internet connection is established via a GSM modem. This way, depending on your GSM tariff, you will avoid additional costs.

### 11.3.7 Activating SMA Smart Home

- Setting only possible under **Extended configuration**.

Setting	Explanation
EEBUS protocol	By activating the EEBus protocol (further information at <a href="https://www.eebus.org/">https://www.eebus.org/</a> ), you enable devices with an EEBus interface to connect to the Sunny Home Manager. This way, this measured energy data can be read out from the Sunny Home Manager via the EEBus data connection.
Forecast-based battery charging*	Forecast-based battery charging is based on the production and consumption forecast of your smart home for the next 48h.
Required state of charge (SOC) in terms of forecast-based charging*	This function disables forecast-based charging until the battery is charged to the specified % value (SoC = State of Charge). If this value is reached, the Sunny Home Manager enables forecast-based battery charging function.
Charging of battery prior to optional loads*	If you enable this function, the battery charge is prioritized over an optional load that you have defined.

\* Only displayed for PV systems with battery

**Procedure:**

- Go to **SMA SMART HOME Settings** and select **Active** under **EEBUS protocol**.

#### Setting up Forecast-Based Battery Charging

 Strings must be configured in the system.

**Procedure:**

1. Go to **SMA SMART HOME Settings** and select **Active** under **Storage management via the Home Manager**.  
Only check the box if the active power limitation system is active.  
 Another setting option opens:
2. Enter the required value under **Required state of charge (SOC) in terms of forecast-based charging**.
3. **i** **Configuration may lead to derating losses**  
The electricity generation and consumption forecast is not taken into account up to this entered value. This could cause the energy to be reduced because the battery does not have sufficient free capacity for storage.
4. If the battery needs to be charged prior to a defined optional load, select **Active** under **Charging of battery prior to optional load**.
5. Click on **[Save]**.

**11.3.8 Configuring the External Current Transformer**

- Setting only possible under **Extended configuration**.
- If the integrated measuring unit of the Sunny Home Manager is connected directly, it can measure a maximum current of 63 A per phase. Current transformers must be used to measure currents > 63 A per phase (see Section 8.2.3, page 27).

**Procedure:**

1. For the request **External current transformer**: click on **Yes**.
2. Enter the specified transformation ratios (default setting: 1 each) in the fields **Primary current**: and **Secondary current**:
3. Click on **[Save]**.

**11.3.9 Reconfiguring the Energy Meter**

In the **Meter configuration** area the data are displayed that were entered during commissioning and registration of the system (see Section 9.1.4, page 32)

- Change only possible under **Extended configuration**.

**i** **Only reconfigure the energy meter for changes that are absolutely necessary.**

This might be the case, for example, if the grid operator demands a faster reaction for the dynamic active power limitation or the zero feed-in (zero export).

**Procedure:**

1. At the bottom of the tab select **[Edit]** for the device setting of the Sunny Home Manager.
2. In the **Meter configuration** area in the fields **Supply and feed-in** as well as **PV power generation**, select the desired feed-in and grid-supply meter as well as PV generation meter from the drop-down list:
3. Select the desired measuring interval from the drop-down list **Measuring interval internal energy meter**.  
Default setting: 1000 ms; adjustable intervals: 200, 600 or 1000 ms  
Tip: Set the interval to 200 ms to achieve the maximum possible control speed of SMA PV inverters or battery inverters. (When it comes to battery inverters, the firmware version is to be updated if necessary.)
4. The input fields belonging to the **Direct meter communication** are usually left empty; IP addresses must be entered here only in case of communication problems.
5. Click on **[Save]**.

## 11.4 Adding and Configuring the Inverter

### Requirement:

- You must have the user role **Installer** or **PV System Administrator** (see Section 16.1, page 108).

### 11.4.1 Adding an Inverter

#### Requirements:

- The new device must be in operation.
- For the new SMA device, either the default password **1111** (factory-preset) for the user group **Installer** or the system password of the existing system must be set (see Section 17.3, page 112).
- In the new device this must be set: **Data collection activated** (see Section 11.1.4, page 53).
- For the Sunny Home Manager this must be set: **Data request interval Automatic** (see Section 11.3.6, page 57).

#### Procedure:

1. Under **Configuration > Device overview** select the tab **Overview of new devices**.
2. Select device after preselection via the device filter or in the list and activate via .
  - The configuration wizard opens and provides the further procedure step by step.
3. Enter the device name. You can also select and edit one of the suggestions displayed.
4. Enter the **Phase** and **Generator power** in the device properties.
5. When required, activate inverter comparison and enter a percentage value for the tolerance in the system monitoring.
6. Select [**Next**].
  - A summary of your entries is displayed.
7. If the data are correct, select [**Finish**].
  - The new SMA device is displayed under **Configuration > Device overview**.

### Replacing an inverter

It can take up to 20 minutes to replace an inverter using the configuration wizard.

### 11.4.2 Entering Line Conductors

Sunny Portal can display in the devices classes **Photovoltaic inverter** and **Battery inverter** the line conductor(s) to which each inverter is connected. For this, you must enter the line conductors.

#### Procedure:

1. In the checkbox **Phase**, activate the line conductor(s) to which the inverter is connected.
2. Click on [**Save**].

### 11.4.3 Entering the PV Array Power

The PV array power is the maximum power of the PV modules connected to one **photovoltaic inverter**.

You can:

- Calculate the PV array power via the string properties (see Section 11.4.4, page 61)
- or**
- enter the PV array power manually.

SMA Solar Technology AG recommends calculating the PV array power via the string properties. A string describes a group of series-connected PV modules. Normally, a PV system is made up of multiple strings. Each string has specific properties, such as deviation to south (azimuth) or the roof tilt angle.

Entering the string properties provides the following advantages:

- Sunny Portal can determine the PV array power more precisely.
- The Sunny Home Manager can deliver more exact yield forecasts and control loads more efficiently.

### Enter the PV array power manually

You can find out the connected PV array power present on each inverter from your installer. Using the PV array power, Sunny Portal can calculate your nominal PV system power.

#### **i** Nominal PV system power required for limiting active power feed-in

You must enter the PV array power correctly to ensure limitation of the active power feed-in to the correct value. If there are changes to the installed PV array power, you will need to adjust this value.

#### Procedure:

1. In the area **Generator capacity**, enter the PV array power in the text field **kWp**.
2. Click on **[Save]**.

## 11.4.4 Configuring Strings

The configuration of the strings is of fundamental importance for the correct calculation of the PV forecast and thus an important prerequisite to correctly allow for the MUST/CAN loads.

#### Requirement:

- The system must contain at least 1 inverter.

#### Creating a new string

1. Under **Configuration > PV system properties** select the tab **String configuration** and then **Add string**.
2. Enter the string properties:

Text box	Explanation
Inverters	From the drop-down list select an inverter to which the string is to be assigned (see Section 11.1, page 50). You can register the connected strings for all inverters. To initially register the same configuration for all devices, select <b>Apply for all inverters</b> when adding a string.
Designation	Name of the string, e.g. <b>String A</b> or <b>East side</b>
Manufacturer	PV module manufacturer
Module type	Depending on the selected manufacturer, different module types are displayed in the drop-down list.
module power*	These values are applied automatically from the module database once you have selected the module type. You can change the values using  or the arrow keys on the keyboard.
Module surface	
Efficiency	
Number of modules*	Number of modules forming the string

Text box	Explanation
Azimuth	<p>The azimuth angle indicates by how many degrees the module surfaces deviate from a southern orientation.</p> <ul style="list-style-type: none"> <li>In the text field, enter the number of degrees by which the module surfaces deviate from a southern orientation. Enter a negative value (e.g. <b>-20</b>) for a deviation to the east and a positive value (e.g. <b>20</b>) for a deviation to the west.</li> <li>If the module surfaces track the sun automatically, activate the checkbox <b>Tracking</b>.</li> </ul>
Tilt angle	<p>The tilt angle indicates by how many degrees the module surfaces deviate from the horizontal. In some systems, the module surfaces are optimally aligned according to the latitude. In Germany, the optimum orientation is 30 degrees from the horizontal.</p> <ul style="list-style-type: none"> <li>In the text field, enter the number of degrees by which the module surfaces deviate from the horizontal.</li> <li>If the module surfaces are optimally aligned according to the latitude, activate the checkbox <b>Optimized</b>.</li> </ul>
Description	Optional, e.g. <b>String A - Orientation to the east</b>

\* These fields are necessary for calculation of the nominal system power.



3. Select **[Accept]**.
4. Click on **[Save]**.

### Accept an existing string and edit

#### Requirement:

- At least 1 string must already be configured in your system.

#### Procedure:

1. Select a string or inverter shown in the table on the tab **String configuration**.
2. In the line of the selected string and the column **Copy**, select .
3. In the column **Edit** of the copied string line, select .
  - The menu for setting the string opens.
4. Enter the string properties:
5. Click on **[Save]**.

## 11.5 Adding a Radio-Controlled Socket

#### Requirements:

- The new device must be in operation.
- In the new device this must be set: **Data collection activated** Activating/Deactivating Data Collection.
- For the Sunny Home Manager this must be set: **Data request interval Automatic** Setting the Data Request Interval.

#### Procedure:

1. Under **Configuration > Device overview** select the tab **Overview of new devices**.
2. Select device after preselection via the device filter or in the list and activate via .
  - The configuration wizard opens and provides the further procedure step by step.
3. Enter the device name. You can also select and edit one of the suggestions displayed.
4. Select **[Next]**.

5. In the drop-down list select the **Load** that is connected to the radio-controlled socket.  
If the desired load is not available, select **No assignment** and then add the new load for this radio-controlled socket later.
6. Select [**Next**].
  - A summary of your entries is displayed (see the following example).
7. If the data are correct, click on [**Finish**].
  - You are automatically forwarded to the tab **New load** of the configuration page **Load overview and planning** to configure the new load.

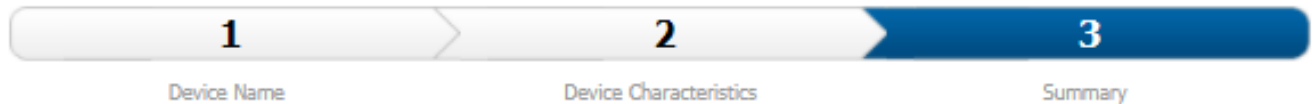

### Edimax Smart Plug - PV System Extension



**Serial Number:**

Wenn die Daten richtig sind, wählen Sie "Fertigstellen".

**Device Name:** Edimax 7B1

**Load:** No assignment

← Back
Cancel

Finish

Figure 13: System extension with radio-controlled socket (example)

Detailed information on the configuration of new loads can be found under **Load overview and planning** Load Overview and Planning.

## 11.6 Replacing the Sunny Home Manager

### Requirements:

- You must have the user role **Installer** or **PV System Administrator** (see Section 16.1, page 108).
  - The Sunny Home Manager to be replaced must have been decommissioned (see Section 19.1, page 126).
  - The new Sunny Home Manager must be reset prior to the replacement:
    - Ex works (new device)
    - Manually (already used device)
  - The new Sunny Home Manager must have been commissioned:
    - The new Sunny Home Manager must be connected to the router (see Section 8.3.2, page 28).
    - The new Sunny Home Manager must be supplied with voltage (see Section 8.2, page 25).
- i** Keep the serial number and the registration ID of the new Sunny Home Manager ready. (These data can be found on the type label that is attached on the side of the device or on the label provided.)

### Procedure:

1. Log in to the system setup assistant and enter the access data (see Section 9.1.1, page 30).
2. Select [**Next**].
  - The page **Select PV system** opens.

3. Activate the field **Add or replace devices**.
4. Select  in the line of the Sunny Home Manager system for which you want to replace the Sunny Home Manager.
5. Select [**Next**].
  - The page **Select devices** opens.
6. Enter the identification key of the Sunny Home Manager in the field **PIC**. Enter the registration ID of the Sunny Home Manager in the field **RID**.
7. Select [**Identify**].
  - Sunny Portal checks whether the identification key and registration ID correspond to the connected Sunny Home Manager.
8. If the system setup assistant does not find a Sunny Home Manager with this information, rectify the error (see Section 18, page 114).
9. Select [**Next**].
10. Select [**Finish**].

### 11.6.1 Resetting the Sunny Home Manager

**i** A Sunny Home Manager must only be reset if it had been installed in another system previously.

#### Reset to default setting

- To reset the Sunny Home Manager to the default settings, hold down the reset button with a pointed object (between 2 and 6 seconds) until the LEDs flash red.
  - LEDs flash first green and then red.

Pressing down and holding the reset button for less than 2 seconds has no effect.

#### **i** Loss of data due to replacement or due to resetting to default settings

If the Sunny Home Manager is reset to the default settings, all data saved in the Sunny Home Manager will be deleted. The data saved in Sunny Portal can be transmitted to the Sunny Home Manager after calling up the PV system again in Sunny Portal.

#### Restart

A restart is only required if devices are connected to the Sunny Home Manager via EEBUS (see technical information "SMA SMART HOME - Load energy management using EEBUS").

- To restart the Sunny Home Manager, hold down the reset button with a pointed object until the LEDs stop flashing red (at least 6 seconds).
  - LEDs go out. The status LED then glows red constantly during system startup.

### 11.6.2 Reassigning the Sunny Home Manager to the Sunny Portal System after the Reset

If you have performed a complete reset of the Sunny Home Manager, you must reassign the Sunny Home Manager to your Sunny Home Manager system in Sunny Portal. Otherwise, Sunny Portal will not accept any data from the Sunny Home Manager.

When you log in the portal after resetting the Sunny Home Manager, a notice is shown automatically stating that the Sunny Home Manager has been reset and asking whether you want to reassign the Sunny Home Manager to the system.

#### Requirement:

- You must have the user role **Installer** or **PV System Administrator** (see Section 16.1, page 108).



**Procedure:**

1. Open **www.sunnyportal.com** and select **System setup assistant**.  
**or**  
Go to **www.sunnyportal.com/register**.
  - The system setup assistant opens.
2. Select [**Next**].
  - The page **User registration** opens.
3. Activate the checkbox **I am already registered in Sunny Portal**.
4. Enter the e-mail address and the Sunny Portal password in the fields **E-mail address** and **Password**.
5. Select [**Next**].
  - The page **Select PV system** opens.
6. Activate the field **Add or replace devices**.
7. In the line of the Sunny Home Manager system to which you would like to reassign the Sunny Home Manager, select .
8. Select [**Next**].
  - The page **Select devices** opens.
9. Enter the identification key of the Sunny Home Manager in the field **PIC**. Enter the registration ID of the Sunny Home Manager in the field **RID**. Tip: You can read off the identification key and the registration ID from the type label on the side of the Sunny Home Manager or from the supplied label.
10. Select [**Identify**].
  - Sunny Portal checks whether the identification key and registration ID correspond to the connected Sunny Home Manager.
11. If the system setup assistant does not find a Sunny Home Manager with the entered data (PIC and RID), an error is present that needs to be rectified (see Section 18 "Troubleshooting", page 114).
12. Select [**Next**].
13. Select [**Finish**].

## 11.7 Deleting devices from Sunny Portal

**Requirement:**

- You must have the user role **Installer** or **PV System Administrator** (see Section 16.1, page 108).

** Device data is irretrievably deleted**

If you delete a device, all the data of that device is irretrievably deleted.

- Check whether it is sufficient to deactivate the device.

**Procedure:**

1. Select the device properties of the device.
2. Select [**Edit**].
3. Select [**Delete**].
  - A window with a security prompt opens.
4. To irretrievably delete the device, select [**Delete**].

## 12 Load Control

### 12.1 Background Information

A load is a device in a household that is operated with electrical energy.

**i** Loads that are only switched on when they are needed immediately afterwards (e.g. a toaster or vacuum cleaner) are not suited for being controlled by the Sunny Home Manager.

Well suited are loads whose use is flexible in terms of time (e.g. washing machine, heat pump, charging station for electric vehicles).

A distinction is made between the two types of loads that are suited for being controlled by the Sunny Home Manager:

- Non-program-controlled loads
- Program-controlled loads

Control through Sunny Home Manager	Explanation
Non-program-controlled loads	<p>These loads must be able to switch on and off as needed.</p> <p>The load can be switched on at any time. In other words, Sunny Home Manager can select one or more periods within the user-defined time frame in which it can switch the load on or off.</p> <p>The load can optionally be switched on whenever there is enough PV energy or whenever the actual energy costs fall below the configured maximum threshold.</p> <p>The load can also be switched off quickly if the switch-on condition is no longer met, as when the weather suddenly changes. To prevent loads from being switched on and off too frequently, you can configure a minimum switch-on time and a minimum switch-off time when configuring the load properties (see Section 12.4.6, page 74).</p> <p>To see an application example that uses a non-program-controlled load, see the "SMA SMART HOME - Load control via CAN time period (example: pond pump)" technical information in the download area of Sunny Home Manager at <a href="http://www.SMA-Solar.com">www.SMA-Solar.com</a>.</p>
Program-controlled loads	<p>Sunny Home Manager should automatically switch the load on and off so that the load mostly consumes PV energy and incurs the lowest-possible energy costs during operation.</p> <p>A program-controlled load runs through a preset program during operation. The program is typically selected by the user prior to operation and started by pressing the start button on the load. Once the program has started, the load should no longer be switched off. Typical program-controlled loads include washing machines, dishwashers and clothes dryers.</p> <p>Sunny Home Manager can only control a program-controlled load if, after an interruption in the power supply, the load's program picks up at the point where the power supply was interrupted.</p>

To have loads captured and controlled by the Sunny Home Manager, you must establish a connection between the load and Sunny Home Manager:

- Via radio-controlled sockets as intermediate switches (not directly communicating loads)
  - Capturing the energy consumption of individual home appliances: measuring function of the radio-controlled socket

- Controlling household appliances: on/off function of the radio-controlled socket
- Via the standard protocol interfaces (directly communicating loads)

Connection option	Explanation
Switching and measuring via radio-controlled sockets	<p>In the Sunny Home Manager system, radio-controlled sockets can switch connected loads on and off. The radio-controlled sockets can also measure the energy consumption of the connected loads and transmit this value to the Sunny Home Manager. For this purpose, the radio-controlled sockets must be assigned as devices to the Sunny Home Manager system (see Section 11.2.1, page 54).</p> <p>A load can either be permanently connected to the same radio-controlled socket or successively to alternate radio-controlled sockets. For each change, the load must be assigned to the new radio-controlled socket (see Section 12.5.1, page 75). If the load is not assigned to a radio-controlled socket, the Sunny Home Manager cannot control this load or receive any consumption data from this load.</p> <p>Since the Sunny Home Manager does not receive any detailed data on loads if they are controlled via radio-controlled sockets, you will need to make additional settings in the load profiles depending on the respective load type. Thus, the Sunny Home Manager can effectively schedule the loads in the load control and optimize energy and cost savings.</p>
Direct communication of devices using data exchange protocols (EEMBus, SEMP)	<p>This connection option is only possible for the following devices:</p> <ul style="list-style-type: none"> <li>• Smart appliances which communicate with the Sunny Home Manager via a data exchange protocol such as EEMBus or SEMP (see Section 12.8, page 79)</li> </ul> <p>The load has an internal EEMBus or SEMP interface and is connected via network cables or Wi-Fi to the local network in which the Sunny Home Manager is also located. Thus, the load can automatically send information on its energy requirement and consumption to the Sunny Home Manager and it can also receive switch-on and switch-off commands from the Sunny Home Manager.</p>

## 12.2 Configuring Radio-Controlled Sockets

### 12.2.1 Safety when Configuring Radio-controlled Sockets

#### ⚠ WARNING

##### **Danger to life by switching medical devices**

Unintentional switching of medical devices can result in life-threatening situations.

- Do not connect any medical devices to the radio-controlled socket.

#### ⚠ WARNING

##### **Risk of injury and fire due to unintentional and unattended switching on of loads**

Loads that are switched on via a radio-controlled socket unintentionally and while unattended can cause injuries and fires (e.g. an iron).

- Do not connect any loads to the radio-controlled socket that could endanger persons or cause damage if unintentionally switched on.

## NOTICE

### Damage to loads

Frequently switching a load on and off can damage it.

- Ask the load manufacturer whether the load is suitable for control via a radio-controlled socket.
- Configure the radio-controlled socket so that the load connected is not switched on or off more frequently than specified by the load manufacturer.
- Do not connect any loads to the radio-controlled socket if they require a continuous current supply.

## 12.2.2 Requirements for Configuring Radio-Controlled Sockets

- The radio-controlled socket must have been commissioned and registered in Sunny Portal (see Section 11.2.1, page 54).
- For the Sunny Home Manager this must be set: **Data request interval Automatic** (see Section 11.3.6, page 57).
- The data collection of the radio-controlled socket must be set to **Active** (see Section 11.1.4, page 53).

## 12.2.3 Selecting the Load

In order that the radio-controlled socket can be controlled by the Sunny Home Manager, you must assign a load to it. You will first need to create a load profile for the load (see Section 12.4, page 72). If you have already installed a commissioned radio-controlled socket without assigning a load, you can subsequently assign this radio-controlled socket to the required load when creating the load profile.

### Procedure:

1. Call up the properties of the radio-controlled socket (see Section 11.1.2, page 51).
2. Select **[Edit]**.
  - The menu for setting the device properties opens.
3. Select the connected load from the drop-down list **Loads**.

## 12.2.4 Entering the Device Name

Using the device name, you can identify the radio-controlled socket in the Sunny Home Manager system.

### Procedure:

- Enter the desired device name in the text field **Device name**, for example, **radio-controlled socket washing machine basement**.

### **i** Device name and identification of Edimax radio-controlled sockets

The serial number of the radio-controlled socket is encoded in the automatically generated device names of the Edimax outlets. This allows the SMA radio-controlled socket to be identified by comparing with the type label. SMA Solar Technology AG recommends in this case keeping the device name that was automatically generated while registering the radio-controlled socket.

### **i** Device name and identification of AVM radio-controlled sockets

The serial number of the devices in Sunny Portal corresponds to the actuator identification number (AIN) of the radio-controlled sockets. Since the device names in the Sunny Portal and the FRITZ!Box website may differ, this is one way to identify a single radio-controlled socket. The AIN can be found on the back of the radio-controlled socket as well as on the user interface of the Fritz!Box under **Home network > Smart home > Smart home devices**. There select the button to edit the properties. The AIN and other information about the selected device will now be displayed.

### 12.2.5 State of the radio-controlled socket after load operation

**i** Depending on the load type, the radio-controlled socket is either switched on or switched off after load operation.

- Load is program-controlled: switched on
- Load is not program-controlled: switched off

The radio-controlled socket also switches to the respective state if the connection between the Sunny Home Manager and the radio-controlled socket is interrupted for more than 15 minutes. In this case, you must then reset the radio-controlled socket to the **Automatic** operating mode.

Upon expiry of the set time period, the load remains in operation until the previously set target value (e.g. target temperature for a heat pump) is reached. You must set the target value directly on the load (see manual for the load).

### 12.2.6 Configuring the Operating Mode

#### Requirements:

- The radio-controlled socket must be assigned to the connected load (see Section 12.2.3, page 68).
- In Sunny Portal, the data request interval must be set to **Automatic** (see Section 11.3.6, page 57).

#### Procedure:

1. In Sunny Portal select **Load balance and control** in the page and menu selection.
2. Select the **Current** tab.
3. In the table, in the column **Operating mode**, select the button for the desired operating mode next to the required load.

Op. mode	Explanation
<b>Switch on</b>	No control of the SMA radio-controlled socket by the Sunny Home Manager The SMA radio-controlled socket is switched on and switches to the operating mode <b>On</b> . The connected load can draw electric current.
<b>Switch off</b>	No control of the SMA radio-controlled socket by the Sunny Home Manager The SMA radio-controlled socket is switched off and switches to the operating mode <b>Off</b> . The connected load cannot draw electric current.
<b>Automatic</b>	Control of the SMA radio-controlled socket by the Sunny Home Manager Depending on the current control command of the Sunny Home Manager, the SMA radio-controlled socket is either switched on or off in this mode. This operating mode cannot be set for the load type <b>Measure only</b>

**i** You can also configure the operating mode of the radio-controlled socket via the Sunny Portal app or the keys on the radio-controlled socket and change the current switching state (on/off).

### 12.2.7 Configuring Start-up Detection

Since the Sunny Home Manager has an automatic start-up detection, you no longer have to manually set the radio-controlled socket to the operating mode **Automatic**. This is an advantage, for example, if the SMA radio-controlled socket is difficult to access behind the dishwasher.

With start-up detection activated, the radio-controlled socket detects when the load starts a program and switches the load off again instantly. Then, the Sunny Home Manager can schedule the load into the load control accordingly and at the appropriate time switch the load back on automatically via the radio-controlled socket.

Sunny Home Manager blocks start-up detection for the duration of the load's maximum program operating time in order that the program can run without interruption even with fluctuations in the power consumption of the load. You specify the maximum program operating time when configuring the load.

**Requirements:**

- The load must be a **dishwasher, washing machine** or **self-configured** (see Section 12.4.2, page 73).  
With other program-controlled loads, the power consumption right after switch-on is normally too low for start-up detection.
- The load must be connected to the energy management system via a radio-controlled socket compatible with the Sunny Home Manager.
- The SMA radio-controlled socket must be **Switched on** (see Section 12.2.6, page 69).
- In order that start-up detection can be activated, the radio-controlled socket must have at least the firmware version 12.12.110.R and be in the operating mode **Manual switch-on**.

**Procedure:**

1. Select **Active** in the **Start-up detection** field.
2. Enter the runtime of the longest program of the load in the **Max. Program Operating Time** field.
  - This time is used as a locking time so that no starting process is detected within a running program.
3. If required, in the text field **Power threshold for detection**, adjust the preset threshold for the power consumption of the load during start-up. Information on power consumption during start-up can be found in the load's manual.
4. If required, in the text field **Detection time**, adjust the preset time period over which the threshold of the power consumption must be exceeded before a start-up of the load is detected.
5. Click on **[Save]**.
6. If required, in the text field **Detection time**, adjust the preset time period for which the threshold of the power consumption must at least be exceeded in order to detect standby mode.

**i Direct start of a load despite enabled start-up detection**

If you wish to start the load right away even though start-up detection is activated, the operating mode of the radio-controlled socket must be set to **On** even after starting the load's program (e.g. by activating the key on the radio-controlled socket, via the Sunny Portal app or in Sunny Portal via the page **Load balance and control**, tab **Current**). This way, the load can start immediately and, in the radio-controlled socket, the start-up detection is blocked again so that the load program can run without being interrupted by the start-up detection.

**i Manual switching of a radio-controlled socket after detected start-up**

If a start-up has been detected and the button on the radio-controlled socket is pressed manually during the program run of the load, the Home Manager automatically sets a locking time of 3 hours for the start-up detection. The start-up detection remains switched on, i.e. a start-up can be detected again after the locking time.

**i Special case Initial commissioning**

The radio-controlled socket is in manual mode and is switched off (e.g. factory setting). When the radio-controlled socket (see Section 12.2.6, page 69) is switched on, the locking time is initially set to 3 hours. This prevents a start-up from being detected immediately when start-up detection is switched on. A started load is not interrupted in this case. The Home Manager can then take over control and set the locking time.

## 12.3 Load Overview and Planning

This menu page is divided into two areas:

- **Load overview** - shows the loads that are configured for use with Sunny Home Manager.  
You can view and change the configuration at any time or add new loads.
- **Load planning** - provides a graphical overview of the scheduled time periods in which the active loads must be operated (dark-colored bar) or can be operated (light-colored bar).  
Loads with direct communication are not listed here.

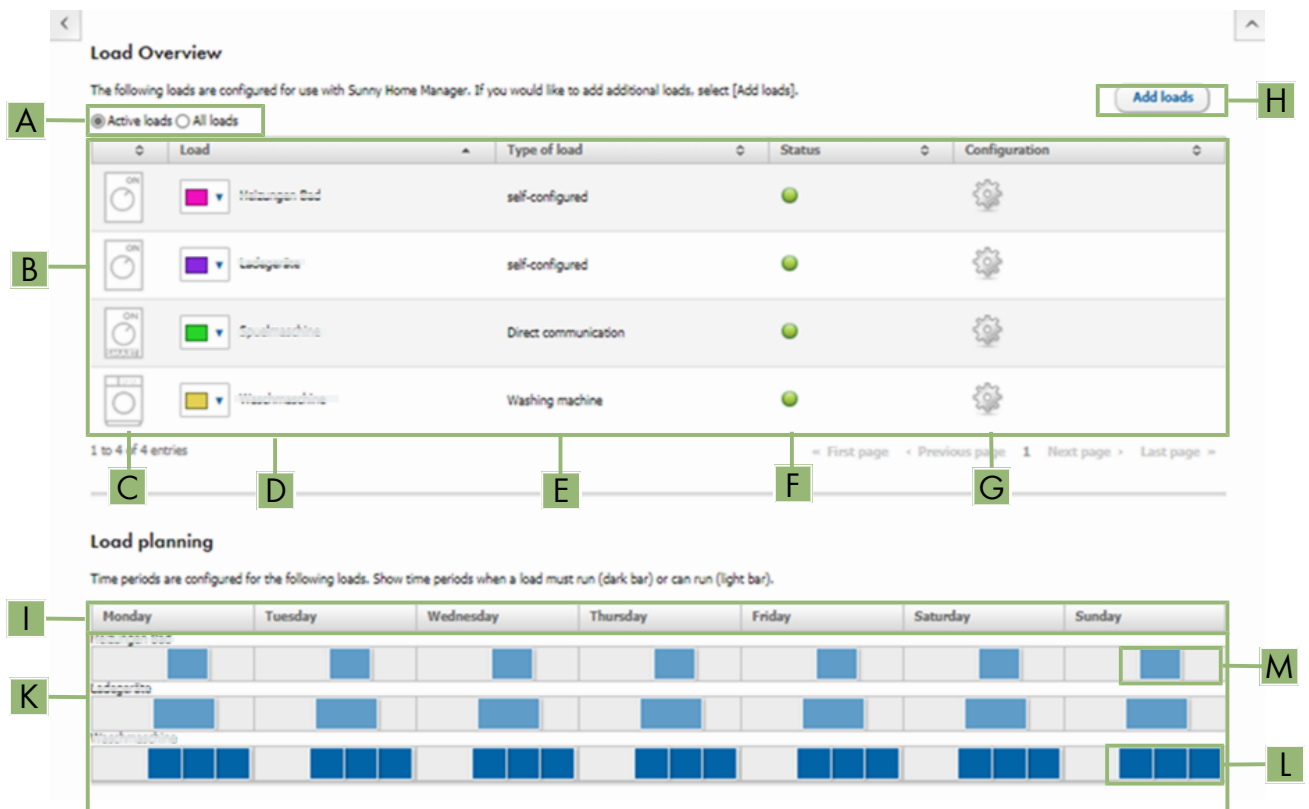

Figure 14: Load overview and planning (example)

Position	Designation	Explanation
A	Filter options	Using the filter options, you can filter the list of loads. Selecting the option <b>Active loads</b> will hide the loads that are currently not assigned to a radio-controlled socket and therefore not controlled by the Sunny Home Manager.
B	Load list	List of loads which have been configured for use with the Sunny Home Manager.
C	Load icon	Symbol of the load
D	Name of load	Name of the load with assigned color A new color can be selected from the color palette.
E	Type of load	Type of the load
F	Status	Status of the load <ul style="list-style-type: none"> <li>● = OK</li> <li>○ = Not active</li> <li>⊕ = Load is not fully configured</li> </ul> Load is fully configured and receives data Load is not assigned to a radio-controlled socket.
G	Configuration	Opens the tab <b>Name of Load</b> , on which you can configure the load properties (see Section 12.4, page 72).

Position	Designation	Explanation
H	Add loads	Using this button, you can add further loads to the Sunny Home Manager system. Smart appliances are recognized automatically by the configuration wizard and are displayed under <b>Device overview &gt; Overview of new devices</b> . Following successful registration, the devices are displayed on the page <b>Load Overview and Planning</b> in the area <b>Load Overview</b> .
I	Weekdays	For each individual weekday time periods can be configured for the loads.
K	Loads with time period setting	Only loads are shown here for which time periods were configured (see Section 12.7, page 77). Loads directly communicating with the Sunny Home Manager are not shown here.
L	Configuring time periods	Light blue bars - CAN time period
M	Configuring time periods	Dark blue bars - MUST time period

## 12.4 Configuring Load Characteristics

**i** As soon as a load has been configured, only the general information can be changed. In order to change a load's configuration once made, the relevant load must be deleted and reconfigured.

### 12.4.1 Entering general information

Regardless of whether you want to configure a new or an already existing load, the tab (new load or name of the load) with the **Load properties** opens.

In order to configure a new load, you should enter the following general information:

General properties	Explanation
Name of load	You can identify the radio-controlled socket and the connected load in the Sunny Home Manager system using the load names. <ul style="list-style-type: none"> <li>Enter a load name in the <b>Name of Load</b> text field, e.g. <b>Washing machine basement</b>. The load name can have a maximum of 24 characters.</li> </ul>
Load icon	<p><b>Select load icon:</b></p> <ul style="list-style-type: none"> <li>Select the desired load icon from the drop-down list to use a standard load icon.</li> </ul> <p><b>Upload load icon</b></p> <ul style="list-style-type: none"> <li>At the bottom of the page select <b>[Upload load icon]</b>.</li> <li>Select the desired file (permitted file formats: JPG, JPEG, PNG, GIF, BMP).</li> <li>Click on <b>[Open]</b>. <ul style="list-style-type: none"> <li><input checked="" type="checkbox"/> The file is uploaded and then displayed in the drop-down list <b>Load icon</b> as the selected new load icon.</li> </ul> </li> <li>Select <b>[Save]</b>.</li> </ul>
Load color	<ul style="list-style-type: none"> <li>Select the desired color from the drop-down list.</li> </ul>



## 12.4.2 Selecting the Load Type

Depending on the selected load type, you can display and configure different load properties on the tab. A preconfigured load profile is stored for some load types. If you select such a load type, some settings are not configurable.

Type of load	Explanation
Self-configured	<p>You configure the connected load individually. With this type of load, you must also state whether the load is program-controlled or if its operation can be interrupted at any time.</p> <p>Example of program-controlled load: dryer</p> <p>Example of load where operation can be interrupted: pond pump</p>
Direct communication	<p>The load is connected via network cable or WLAN to the local network in which the Sunny Home Manager is also located. Thus, the load can automatically send information on its energy requirement and consumption to the Sunny Home Manager and it can also receive switch-on and switch-off commands from the Sunny Home Manager.</p> <p>On of your entries is omitted.</p>
Energy monitoring (measuring only)	<p>Only the power consumption of the connected load is to be measured. (e.g. office outlet or devices that permanently consume electricity such as a refrigerator or devices in standby mode)</p>
Washing machine Dishwasher Stiebel Eltron WWK 300/ WWP300 Tecacolor TTA 300 Heating element	<p>A preconfigured profile is stored for these loads.</p> <p>Some settings (e.g. program controllability) are blocked because they are not configurable for the relevant device.</p> <p>You can use the preconfigured profile or configure the device yourself.</p>

## 12.4.3 Selecting Program Controllability

- This option is only adjustable for the load type **Self-configured**.

Here you specify whether the load must run through predefined programs or not.

Setting	Explanation
Yes	<p>After the start, the load runs through a defined program.</p> <p>Interrupting the load during the course of the program can affect the operation result and should therefore be avoided. (Examples: washing machine, dryer)</p>
No	<p>The load always carries out the same function during operation.</p> <p>Multiple switching on and off per day does not cause any problems. The load does not have to run permanently - as long as a minimum operation time per day is achieved, interruption of operation has no negative effect on the function being carried out. (Examples: pond pump, heating element, water heater)</p>

**i** A washing machine is a program-controlled load. That is why for a washing machine **Yes** is pre-selected and cannot be changed.

## 12.4.4 Entering the Power Consumption

The power consumption is the power (medium watt amount) typically required by a load for operation (see type label or load manual).

The Sunny Home Manager takes account of this value in the initial calculation of the required energy.

Once the load provides measured values of its actual consumption during operation, the Sunny Home Manager can determine a more precise power value after a learning phase. This way, the Sunny Home Manager gradually improves its load planning and increases energy and cost savings.

**Procedure:**

- Enter the power of the load connected in the text field **Power Consumption**.

### 12.4.5 Entering the Maximum Program Operating Time

- The connected load must be program-controlled.

The maximum program runtime is the time that a program-controlled load requires for its longest program. The maximum program operating time defines the latest time at which a load must be switched on so that its longest program can be completed within the specified time limits.



#### Maximum program operating time for a washing machine

You have defined a time slot from 10:00 a.m. to 6:00 p.m. for your washing machine (see Section 12.7, page 77), i.e. your washing machine's washing cycle must be completed by 6:00 p.m.

The longest washing cycle of your washing machine lasts three hours. Therefore, enter at least three hours as the maximum program runtime when configuring the radio-controlled socket. In this case, the washing machine will start at 3:00 p.m. at the latest so that the longest washing cycle can be completed. If the selected washing cycle is of shorter duration, the Sunny Home Manager still adheres to the maximum program runtime.

**Procedure:**

- Enter the maximum program operating time for the load connected in the **Max. program operating time** text field (see the load manual).

### 12.4.6 Entering the Minimum Switch-On and Switch-Off Time

- This option is only adjustable for loads that are not program-controlled.

Setting	Explanation
Minimum switch-on time	<p>The minimum switch-on time is the minimum time that the load connected must remain switched on, for example, to complete its starting sequence or complete a work sequence.</p> <p><b>Delayed activation possible:</b> Some loads may not start to operate immediately after switching on the radio-controlled socket, e.g. heat pumps for water storage tanks. Immediate activation can only be ensured for the radio-controlled socket, not for the connected loads.</p> <ul style="list-style-type: none"> <li>• Enter the minimum switch-on time in the <b>Minimum switch-on time</b> text field. Take into consideration any possible delays in starting the connected load.</li> </ul>
Minimum switch-off time	<p>The minimum switch-off time is the minimum time the connected load must remain switched off, for example, to prevent overheating or enable restarting.</p> <ul style="list-style-type: none"> <li>• Enter the minimum switch-off time in the <b>Minimum switch-off time</b> text field.</li> </ul>

### 12.4.7 Setting the Priority of the Load

This setting will only take effect if you have set the time period type **Load can be switched on**.

In the case of the time period type **Load must be switched on**, the priority of the load does not have any effect, as the load is switched on in any event, possibly also with grid-supplied power.

The priority will only be considered for the following loads:

- Smart appliances with optional energy absorption. You will have already set the priority of these devices when adding them to your Sunny Home Manager system via the configuration wizard.
- Loads connected to radio-controlled sockets for which you have set time periods of type **Load can be switched on**.

The priority of the optional load decides in which order the Sunny Home Manager considers the individual optional loads. For this reason the priority of appliances with low power (e.g. washing machine and dishwasher) should be lower than, for example, the priority of charging devices such as the SMA EV Charger. Basically, the Sunny Home Manager schedules optional loads only if it can ensure that the planning target is met. If the slider is set to 100% PV generation, it is possible that optional loads cannot be scheduled for use on cloudy days because minimum grid-supplied power cannot be excluded.



### Conflict between 2 loads

2 loads, for which you have configured an optional time period in each case, should only be switched on if excess PV energy is available. As the amount of surplus PV energy is currently only sufficient for one load, however, the load with the higher priority is switched on. If both loads have the same priority, the load with the higher level of consumption is switched on first.

#### Procedure:

- Set the slider to the desired level.

## 12.5 Controlling Loads via the Radio-Controlled Socket

### 12.5.1 Assigning Radio-Controlled Sockets

For the following reasons, you must assign the radio-controlled socket to the load to which it is connected:

- to have the load controlled by the Sunny Home Manager
- to have the Sunny Home Manager save the data of the load

If a load was temporarily not assigned to any radio-controlled socket, corresponding data gaps will appear in the diagrams such as **Current status and forecast**.

A load can be connected to another (free) radio-controlled socket at any time and controlled via this; the measured values or consumption data basically remain with the load and can only be called up via the load itself.

#### Procedure:

- In the drop-down list **Radio-controlled socket**, select the radio-controlled socket to which the load is connected. By default, no radio-controlled socket is assigned to the load.

If the desired radio-controlled socket is already assigned to a different load, a "\*" will be displayed in front of the name of the radio-controlled socket. In order to be able to reassign the radio-controlled socket, you must first remove the assignment of the radio-controlled socket in the profile of the other load.

## 12.5.2 Setting Measuring and Switching of the Radio-Controlled Socket

- In the drop-down list **Measuring and switching**, select the required setting.

Setting	Explanation
Radio-controlled socket is to measure and switch (intelligent power consumption)	<p>The load draws electric current via the radio-controlled socket.</p> <p>Using the consumption values measured by the radio-controlled socket, the Sunny Home Manager "learns" how much power the load typically consumes. This information flows into the load control of the Sunny Home Manager.</p>
Radio-controlled socket is only to switch, not measure (fixed power consumption)	<p>The load is switched e.g. via a relay which is connected to the radio-controlled socket.</p> <p>Using the connected relay, the radio-controlled socket switches the load only in accordance with the configuration (time period) and the specifications of the Sunny Home Manager.</p> <p>The value that is entered in the load profile in the field <b>Power Consumption</b> is the power consumption factored in for planning the load control.</p>

The radio-controlled socket also switches to the respective state if the connection between the Sunny Home Manager and the radio-controlled socket is interrupted for more than 15 minutes. In this case, you must then reset the radio-controlled socket to the **Automatic** operating mode.

## 12.6 Setting Automatic Switch-Off

If the load has internal automatic switch-off, you must provide additional information in order that the radio-controlled socket can detect whether the load is in operation or in standby mode. This ensures that premature disconnection of the load is avoided, so that it can also run for longer than the configured time period (see Section 12.7, page 77) if necessary.



### Heating element with automatic switch-off

When controlled via a radio-controlled socket, the heating element is switched on and off depending on the availability of PV energy within the time period defined. If the automatic switch-off is activated and the water has not yet reached the set temperature at the end of the time period, the heating element can continue to draw electric current from the radio-controlled socket even though the time period has expired, until the target temperature is reached and the heating element has switched to standby mode on its own. The Sunny Home Manager recognizes the standby mode of the heating element and switches the radio-controlled socket off.

#### Requirements:

- The load must not be program-controlled.

#### Procedure:

1. In the field **Load has internal automatic switch-off**, activate the checkbox **Yes**.
2. If required, in the text field **Threshold for disconnection**, enter the lower threshold for the power consumption of the load in standby mode (typically 50% of the mean power consumption in operation). When the power consumption falls below this threshold, the Sunny Home Manager recognizes the switch to standby mode and disconnects the radio-controlled socket.
3. If required, in the text field **Detection time for disconnection**, enter the minimum time period over which the power consumption must be below the lower threshold for disconnection in order that the Sunny Home Manager recognizes the switch to standby mode.

## 12.7 Configuring the Time Period

The time period defines in which time period the Sunny Home Manager can or must switch the loads on. Time periods can only be configured for loads that are connected to radio-controlled sockets. You can set several time periods for each of these load.

By default, a daily time period is set so that the load is switched on within the time period (load **MUST** be switched on). The time periods configured according to weekdays are shown as colored bars in the **Load planning** area:

Color	Explanation
Dark blue	Compulsory time period The load will always be switched on during the time frame.
light blue	Optional time period The load will only be switched on during the time period if certain conditions have been met (see below).
Red	Invalid time period configuration It is possible that the time period overlaps with other already configured time periods, or that the time period is too short for the entered minimum switch-on time of the load.

### **i** Length of time period

The time period within which the load is supposed to be operated must be significantly longer than the actual operating duration so that Sunny Home Manager has enough leeway within the time period to be able to identify the times when energy is the cheapest.

### **i** Shorter electrical endurance of the radio-controlled socket through the frequent switching of loads

The more often the radio-controlled socket switches loads on and off, the shorter the electrical endurance of the radio-controlled socket.

- When setting time periods and device operating times, ensure that the radio-controlled socket does not have to switch loads on and off unnecessarily often.

### **i** CAN time period: In some cases, the load is not switched on

If the configured proportion of PV energy is not attained or the maximum permissible energy costs are exceeded, it is possible that the load will not receive any energy in the optional time period and the radio-controlled socket is not switched on.

### **i** MUST time period: Load is switched on in any case

The load is also switched on if there is not sufficient self-generated energy available, i.e. energy required for the load to operate may be drawn from the utility grid.

## Setting or changing the time windows

1. Select **Configuration > Load Overview and Planning** in the page and menu selection.
2. In the line of the desired load, in the column **Configuration**, select .
3. In the tab of the selected load, select the button **[Edit]**.
4. Select **[Configure time period]**.
5. In the window **Configure time period**, make the desired changes for the time period:
  - Select load should run **Daily** or **Only on the following weekdays**.
  - Using the slider, set the operating time in 30-minute intervals.
  - Select the time period type or **Load MUST be switched on** or **Load CAN be switched on**. (More details see below.)

- Decide whether the load may run for longer than the set time period.
6. Select [**Accept**].
  7. Click on [**Save**].

### Selecting the Time Period Type "Load Can Be Switched on" or "Load Must Be Switched On"

1. If the load must definitely be switched on within the time period, select **Load must be switched on** (default setting).
2. If the load is only to be switched on under certain conditions within the time period, select **Load can be switched on**.
  - The window **Load will be switched on depending on** opens.
3. Select the **Maximum permitted energy costs** option or the **Proportion of the PV energy** option.

#### Proportion of PV energy:

You can set the load to be switched on only if a certain minimum proportion of PV energy is available to operate the load. If the function **Limiting of the active power feed-in** is activated (see Section 10.4.2, page 44), you can also set the proportion of surplus PV energy that would otherwise be derated.



#### Operating loads with at least 50% PV energy

A washing machine is only to be switched on if 50% of the washing machine's energy requirement can be covered by PV energy.

- The slider is set to **50%**. Only if enough PV energy is available, the washing machine is switched on.

#### Maximum permitted energy costs:

You can set a maximum amount for the energy costs for operating the load. The price range of the slider is based on the highest and the lowest possible energy costs, e.g. the highest energy costs for operation exclusively with expensive grid current and the lowest energy costs for operation exclusively with PV energy, the cost of which is calculated based on the feed-in tariff less the self-consumption tariff. In addition, if **Limiting of the active power feed-in** is activated, surplus PV energy can be taken into account which is free, as it would otherwise be derated.



#### Operating the load exclusively with free energy

A pond pump should only be switched on if there is more PV energy available than is permitted to be fed into the utility grid.

- The slider is set to **0 Euro/kWh**. Only when enough surplus PV energy is available, the pond pump will be switched on.

#### **i** CAN time period: In some cases, the load is not switched on

If the configured proportion of PV energy is not attained or the maximum permissible energy costs are exceeded, it is possible that the load will not receive any energy in the optional time period and the radio-controlled socket is not switched on.



#### **i** MUST time period: Load is switched on in any case

The load is also switched on if there is not sufficient self-generated energy available, i.e. energy required for the load to operate may be drawn from the utility grid.

### Adding an Additional Time Period

If a load is not to run throughout the day, but rather at predefined intervals (e.g. pond pump), you must set up several consecutive time periods for this day. Here, the number of time periods equates to the number of intervals in which the load is to run.



**Procedure:**

1. Select **Configuration > Load Overview and Planning** in the page and menu selection.
2. In the line of the desired load, in the column **Configuration**, select .
3. In the tab **Name of Load**, select the button **[Edit]**.
4. Select **[Configure time period]**.
5. Select **Add time period** .
  - A new time period with the corresponding number will be displayed in the **Time period overview**.
6. Make the desired settings.
7. Select **[Accept]**.
8. Click on **[Save]**.

**Deleting a Time Period**

You cannot delete all the time periods for a load. At least one time period must always be configured for each load. If no radio-controlled socket is assigned to the load, however, the time period has no effect on the operation of the load.

**Procedure:**

1. Select **Configuration > Load Overview and Planning** in the page and menu selection.
2. In the line of the desired load, in the column **Configuration**, select .
3. In the tab **Name of Load**, select the button **[Edit]**.
4. Select **[Configure time period]**.
5. Select the recycle bin symbol  for the desired time period and confirm the security prompt.
6. Select **[Accept]**.
7. Click on **[Save]**.

## 12.8 Directly Controlling Loads

Certain loads can directly communicate with the Sunny Home Manager via SEMP or EEBus protocol (see technical information "SMA SMART HOME - Compatibility List for Loads").

The loads send information via Ethernet or WLAN on the load type, the planned energy requirement, and the preferred operating time period to the Sunny Home Manager.

The Sunny Home Manager factors this information into its load control, and also taking the configured optimization targets in the context of load control into account, sends appropriate start and stop signals to the loads.

**Requirements:**

- You must have the user role **Installer** or **PV System Administrator** (see Section 16.1, page 108).
- The load must either support the data exchange protocol EEBUS or the data exchange protocol SEMP (see the manual of the load and technical information at [www.SMA-Solar.com](http://www.SMA-Solar.com)).

**Procedure:**

1. Connect the load to the local network and carry out the manufacturer-specific registration (see manual of the load). The load must be located in the same local network as the Sunny Home Manager.
  - The Sunny Home Manager detects the new load in the local network.
  - The load is displayed on the page **Device Overview > Overview of New Devices**.

2. Add the load to the Sunny Home Manager system. In the case of loads with optional energy consumption, you can also set the priority and the maximum permissible energy costs.
  - The new load is automatically displayed on the page **Load Overview and Planning** with the available information and setting options.
3. Change the load name if necessary.

## 12.9 Application example forecast-based battery charging

### 12.9.1 Objective and Background Information

#### Objective of using battery storage-systems

The objective of using battery storage systems is to not feed excess PV energy that cannot currently be self-consumed into the utility grid, but instead to store it temporarily in batteries. It is then available and can be used when the self-generated PV energy is not sufficient, e.g. on a gloomy day, in the evening or at night.

System operators are less dependent on the electricity purchased from the utility grid and increase their self-sufficiency quota.

#### Background information on forecast-based battery charging

##### Without forecast-based battery charging

- The battery may already be fully charged by noon and can no longer absorb any excess PV energy. This then leads to the fact that the PV feed-in power at the point of interconnection has to be "derated" if the PV system output exceeds the maximum feed-in line specified by the grid provider at the point of interconnection (see Limitation of active power feed-in).
- It can result in faster calendar aging of the battery if the state of charge is at 100% frequently and over longer periods of time.

##### The following features of the Sunny Home Manager play an essential role for the forecast-based battery charging:

- PV yield forecast  
Thanks to a weather forecast based on Internet data and by adapting this to the local conditions, the Sunny Home Manager can accurately predict solar irradiation for a few hours to a few days (48h).
- Consumption forecast  
The Sunny Home Manager creates an individual load profile on the consumption behavior of the system operator.
- PV curtailment forecast  
From generation and consumption data the Sunny Home Manager identifies when the PV nominal system power would exceed the specified feed-in power at the point of interconnection. Without forecast-based battery charging this PV energy would have to be derated or would not be generated – and thus would get lost.
- Prioritization of loads  
For optional loads the order in which the Sunny Home Manager is to activate them can be determined. A preferred consideration of the battery charging ensures sufficient availability of energy e.g. in the evening and night-time hours.
- Specifying a minimum load capacity of the battery  
Since a purely forecast-based charging of the battery can lead to insufficient stored energy being available when required, a percentage value can be set for the forecast-based charging of the battery, up to which the battery is definitely charged before the Sunny Home Manager enables the forecast-controlled battery charging and starts the energy distribution to the loads in the household.

##### Ideally

- all loads are controlled so as to avoid derating losses and to be able to cover the household's energy demand exclusively with self-produced PV energy.



### The result is that the battery

- always has sufficient PV energy stored to satisfy the current demand.
- still has capacities to absorb PV energy even at the midday peak.
- exhibits rarely and only briefly a state of charge of 100%.

## 12.9.2 Setting up Forecast-Based Battery Charging

### Preliminary considerations and requirements:

- To calculate the expected PV generation, the exact input of the system location (latitude, longitude, altitude) as well as the nominal system power (string configuration) are required.
- For the optimization of the energy costs, feed-in tariff and electricity tariff must be entered. The criteria according to which the costs are to be optimized must be set in the optimization target.
- "Learned" energy balance data (at least load profile of the past 14 days) should be available.
- If the local grid operator requires a limitation of the active power feed-in, this must be specified here (e.g. 70% capping).
- Since the battery should be able to step in as often as possible when energy is needed but is not being self-produced, it makes sense
  - to specify the time period as liberally as possible.
  - to configure the battery as an optional load, but with higher priority.
- So that the battery still has capacities during PV generation peak periods (e.g. midday peak) and curtailment can be avoided, a percentage value for the state of charge should be specified, from which the Sunny Home Manager should consider other loads before the battery continues to charge.

### Procedure:

1. On the configuration page **PV system properties** under the tab **PV system data** check the PV system location entry and adjust if necessary (see Section 10.1.2, page 40).
2. On the configuration page **PV system properties** under the tab **String configuration** check the string configuration and adjust if necessary (see Section 11.4.4, page 61).
3. On the configuration page **PV system properties** under the tab **Parameters** check the following settings and adjust if necessary:
  - Check entry of **Feed-in tariff and electricity tariff** (see Section 10.4.1, page 43).
  - If the local grid operator requires a **Limiting of the active power feed-in**, this must be specified here (e.g. 70% capping) (see Section 10.4.2, page 44).
  - **Set optimization target**(see Section 10.4.5, page 47):  
For each system, either an ecological (maximization of PV self-consumption) or an economic (minimization of energy costs) optimization target can be selected. Depending on the situation (e.g. PV feed-in tariff, electricity procurement costs), the Sunny Home Manager's planning can vary greatly.
4. On the configuration page **Load overview and planning** select the load and configure the **Load properties**:
  - Setting the Priority of the Load (see Section 12.4.7, page 74):  
The priority should be higher than the priority of loads with low power (e.g. washing machine and dishwasher).
5. On the configuration page **Device overview** select the Sunny Home Manager and call up its **Device properties**.
6. In the area **SMA Smart Home settings** make the following settings:
  - In the **EEBUS protocol** field place a checkmark: **Active**
  - If the active power limitation of the system is active, in the field **Forecast-based battery charging** place a checkmark: **Active**

- In the field **Required state of charge (SOC) for forecast-based charging**, change the preset value from 0% to e.g. 60% if applicable.  
The set value indicates the percentage of the battery charge that must be reached before the Sunny Home Manager activates the forecast-based battery charging function, i.e. up to this value the function forecast-based charging is deactivated.
- In the field **Charging of battery prior to optional loads** place a checkmark: **Active**  
This way you ensure that the battery is first charged before the Sunny Home Manager considers other loads such as a heating element, for example.

## 13 Visualization of the energy management

### 13.1 System selection with system list

**i** If only 1 system is assigned to your e-mail address, this menu is not shown to you.

All systems that are assigned to your e-mail address are listed under the menu item **PV system selection**. In the **PV system list** you can choose between the options **Simple list** and **Extended list** and sort the list.

System List	Explanation / display per system
Simple list	<ul style="list-style-type: none"> <li>• Power of the system (kWp)</li> <li>• Date of commissioning</li> <li>• Location of the system (country, zip code, city)</li> </ul>
Extended list	<ul style="list-style-type: none"> <li>• Nominal system power (kW)</li> <li>• Total yield (kWh) for the following time periods:               <ul style="list-style-type: none"> <li>- previous day</li> <li>- Current day</li> <li>- Previous month</li> <li>- current month</li> </ul> </li> <li>• Total yield (kWh) as per meter reading</li> <li>• Specific yield (kWh/kWp) for the following time periods:               <ul style="list-style-type: none"> <li>- current month</li> <li>- current year</li> </ul> </li> </ul>

#### Sorting the System List

- When first calling up the page, the simple list is shown.
- The extended system list is sorted in ascending order in accordance with the specific system yield.

#### Sort the simple list:

1. To sort the simple list, click in the header of the table on the blue title of the column according to which the list is to be created. The list is then displayed in ascending or descending order according to this criterion.
2. To permanently keep this view, click on the field **Show this list after login** and select **[Save]**.

#### Sort the extended list:

1. To sort the list by another value than the specific system yield, click one of the other blue values in the header.
2. To sort the list in descending order, click on the blue value in the header again.

## 13.2 System overview

The menu page **PV system overview** shows all available data of your system. When calling up your system, this overview appears as the home page by default.

When calling up your system for the first time, you can change your home page in the menu **Configuration > System presentation** at any time (see Section 15.4, page 107).

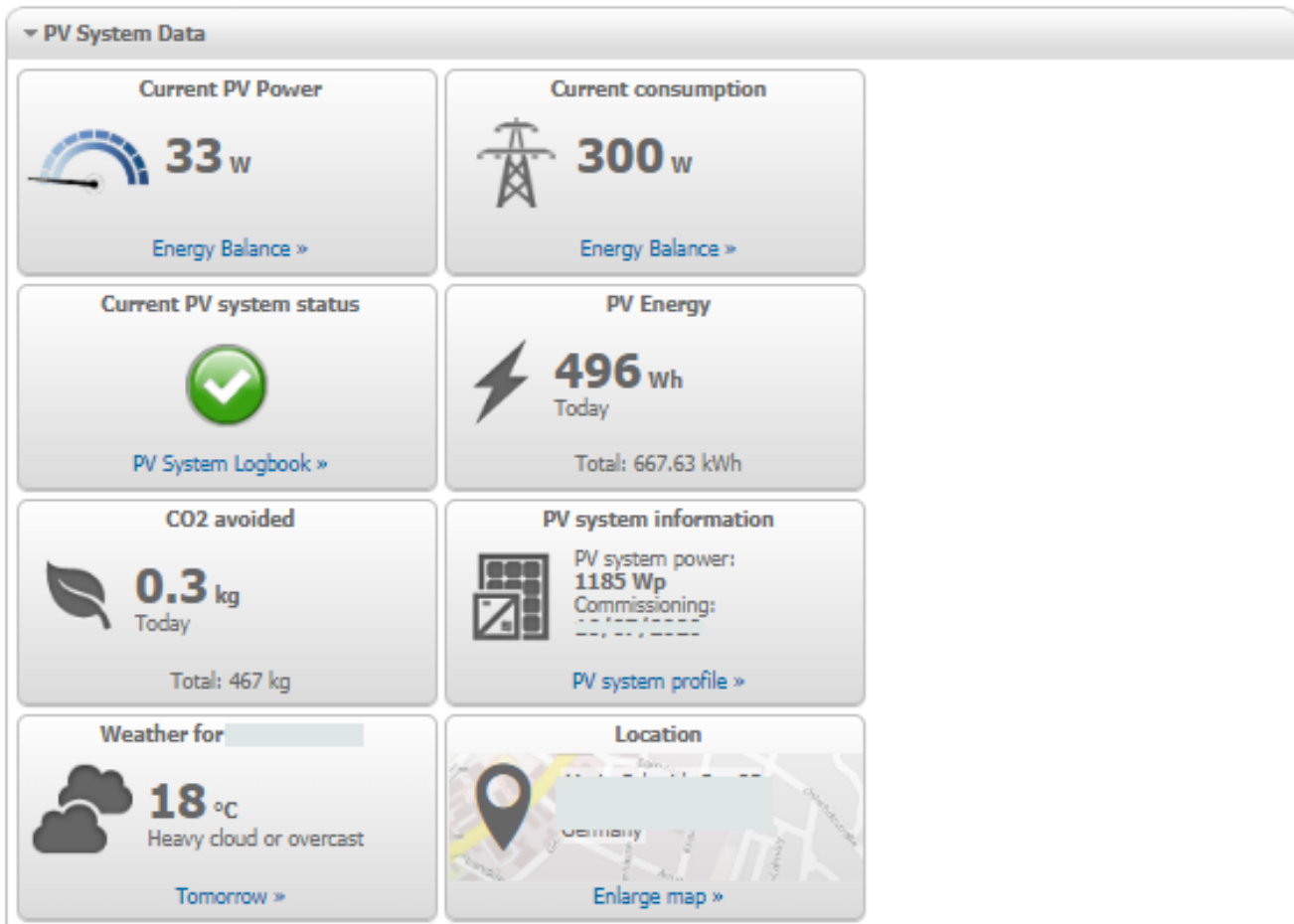

Figure 15: Example of a system

## 13.3 Current Status And Forecast

The Sunny Home Manager continuously logs the energy generated by the PV system. The Sunny Home Manager receives the PV generation data via the connected SMA inverters or via an optionally connected PV generation meter (e.g. an SMA Energy Meter). The Sunny Home Manager also receives location-based weather forecasts via the Internet. Based on this information, the Sunny Home Manager forecasts how much energy your PV system will likely generate in the next 48 hours and thus will be available.

The Sunny Home Manager includes the forecast of the energy availability in its energy planning and suggests cost-effective operating times for home appliances, for example.

To query forecast information, in the **Configuration** menu on the **System properties** page under **PV system data**, the following input fields must be completed:

- Longitude
- Latitude
- Nominal PV system power (necessary for the correct power forecast)

If one of the three entries is missing in the forecast area, either the weather symbols are not displayed, the power forecast is not present or it is incorrect.

### 13.3.1 Overview Current Status Area

The graphic in the area Current Status visualizes the power transferred from your PV system to your household from the utility grid to your household and from your PV system to the utility grid.

#### Requirements for displaying this page:

- The data request interval must be set to **Automatic** (see Section 11.3.6, page 57).

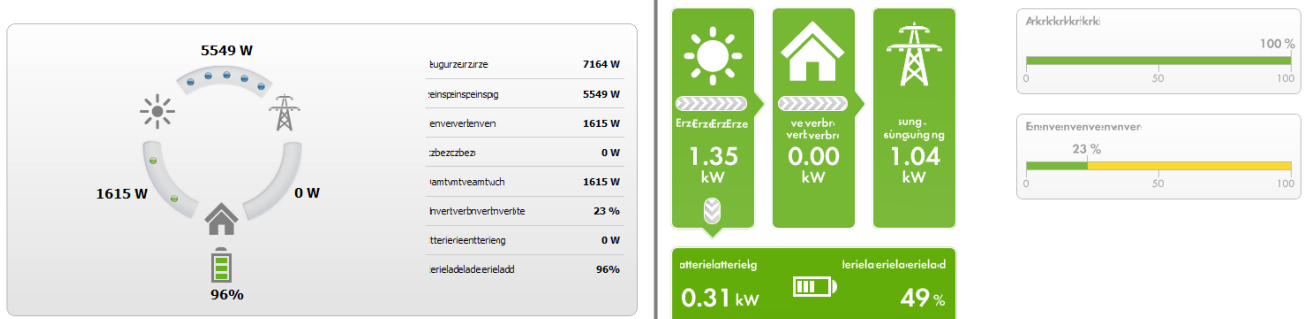

Figure 16: Display: left **Option I** and right **Option II** (examples)

The displays **Option I** and **Option II** contain the following current data:

Designation	Explanation
PV power generation	Currently generated power of your PV system
Consumption (total consumption)	Power that your household is currently drawing from your PV system, the utility grid and the battery for <b>Option II</b> : The colors visualize which portion of the consumption is currently made up of purchased electricity, direct consumption (PV system) and battery discharging.
Grid-supplied power	Power that your household is currently drawing from the utility grid. for <b>Option I</b> : red
Grid feed-in	Power that your PV system is currently feeding in to the utility grid. If your system is generating more power than your household needs at the moment or can be stored in the battery, the surplus power is fed into the utility grid. for <b>Option I</b> : blue
Self-consumption	Power that your household is currently drawing from your PV system (direct consumption) and, if applicable, power/energy being stored into the battery from your PV system. for <b>Option I</b> : green
Self-consumption quota	Current ratio of self-consumption to PV power.
Self-sufficiency quota:	Current ratio of internal power supply to total consumption
<b>Only option II</b>	Internal power supply: Power that your household is drawing directly from your PV system (direct consumption) and, if applicable, from the battery (battery discharging). In systems without batteries, the self-consumption is the same as the internal power supply.
Battery charging*	Power that is being currently charged from your PV system into the battery
Battery discharging*	Power that your household is currently drawing from the battery

Designation	Explanation
Battery state of charge*	Current state of charge of the battery in percent, in relation to the battery capacity

\* Only displayed for PV systems with battery

- i** Only for systems with self-consumption can be chosen between **Option I** and **Option II**.  
For systems without self-consumption only Option I is possible and the configuration block is hidden.

### Changing the display:

1. Select [**Configuration - Current status and forecast**] in the contents area on the page **Current status and forecast**.
2. Select the desired option in the field **Display**.
3. Confirm the selection with [**Save**].

## 13.3.2 Overview Forecast and Recommended Action Area

The graphic in the area Forecast and Recommended Action gives an overview of the expected PV power as well as recommendations on the manual switching-on of loads.

In addition the graphic shows the time periods that you have planned for the operation of the loads Configuring the Time Period.

You can have a forecast displayed for up to 48 hours from the currently selected time.

- i** You can select another period by clicking on the diagram, holding down the left mouse button and moving the mouse to the right or left.

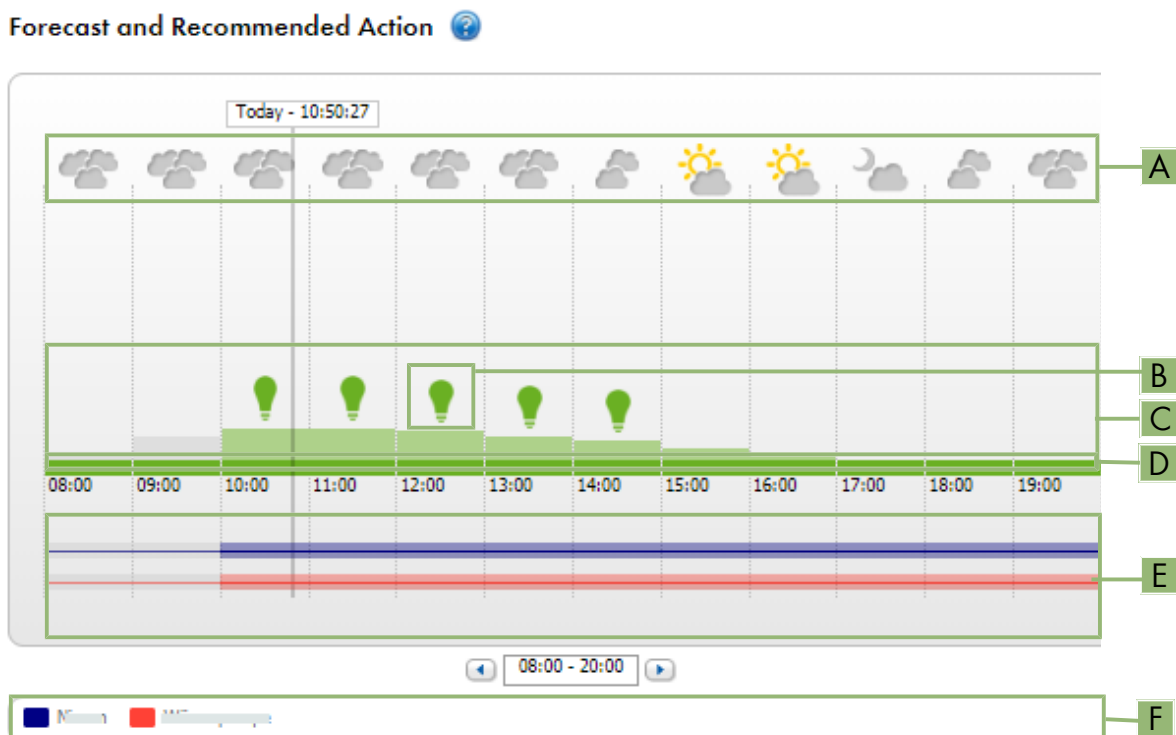

Figure 17: **Forecast and Recommended Action** diagram (example)

Position	Explanation
A	Weather forecast

Position	Explanation
B	<p>Suitable time for manually switching on loads</p> <p>The Sunny Home Manager takes the following information into consideration for the recommended action:</p> <ul style="list-style-type: none"> <li>• Expected PV power (see position C) Requirement: The location of the system must be set.</li> <li>• Expected energy consumption of the household and of loads for which the Sunny Home Manager receives measured values of the power consumed via radio-controlled sockets or via direct communication. The Sunny Home Manager determines the anticipated energy consumption in accordance with the consumption forecast based on the "learned" consumption behavior of the individual household. Requirement: The data collection of the loads must be activated.</li> <li>• Feed-in tariff and electricity tariff Requirement: The feed-in tariff and electricity tariff must be entered.</li> <li>• Optimization target The optimization target indicates whether the Sunny Home Manager should prioritize ecological- or economical factors during load management.</li> <li>• Azimuth and tilt angle Requirement: The inverter strings must be configured.</li> </ul>
C	<p>Expected PV power in accordance with the PV yield forecast</p> <p>The Sunny Home Manager determines the available PV power that can be expected in each case using the weather forecast for the selected location and the "learned" behavior of the specific system.</p> <p>Tip: When you move the mouse over one of the bars, the following details for this time period will be displayed in a window:</p> <ul style="list-style-type: none"> <li>• Estimated PV generation</li> <li>• Estimated consumption</li> <li>• Difference between the estimated PV generation and estimated consumption</li> </ul>
D	<p>Tariff for the electric current purchased from the utility grid</p> <ul style="list-style-type: none"> <li>• Red: expensive</li> <li>• Green: good value</li> </ul> <p>If you have only entered one electricity tariff, green is always displayed.</p> <ul style="list-style-type: none"> <li>• Other colors: electricity tariffs between the highest and the lowest electricity tariff</li> </ul>
E	<p>View of the time periods for the planned operation of the loads (load prognosis)</p> <ul style="list-style-type: none"> <li>• The configured time periods are shown as colored, semi-transparent bars.</li> <li>• Time periods planned by the Sunny Home Manager in which the loads were actually in operation or are going to be in operation are shown as colored, solid bars.</li> </ul> <p>A simple solid line symbolizes times during which the self-consumption of the load is measured.</p>
F	<p>Loads legend</p> <p>The legend shows which color is assigned to which load in the time period view (E).</p>

## 13.4 Energy Balance

This page visualizes the progression of the energy generation and energy consumption for a selected period. provides analyses for generation, consumption, self-consumption and battery usage.

A two-part diagram displays how the loads in your system have been supplied and how your PV energy has been used:

- The upper half of the diagram shows the total consumption of your system in the selected period. It is precisely broken down from which sources your system was supplied with energy (PV system, battery-storage system or utility grid).
- The lower half of the diagram shows when and how much electrical PV energy has been generated and how it was used (direct consumption, charging of a battery-storage system or grid feed-in).

**i** The data on this page are only fully displayed if both a feed-in meter and grid-supply meter are connected. The additionally required PV generation data will be determined either directly by the connected SMA inverters or can be captured via an additional PV production meter in PV systems with Sunny Home Manager. If a DC-coupled storage system is used (e.g. Sunny Boy Smart Energy), the PV production data must always be read out directly from the device, otherwise no differentiation between direct consumption and battery charging or discharging is possible.

Via **Tabs** you can select the period which is to be displayed in the view (current / day / month / year / total).

## Energy Balance

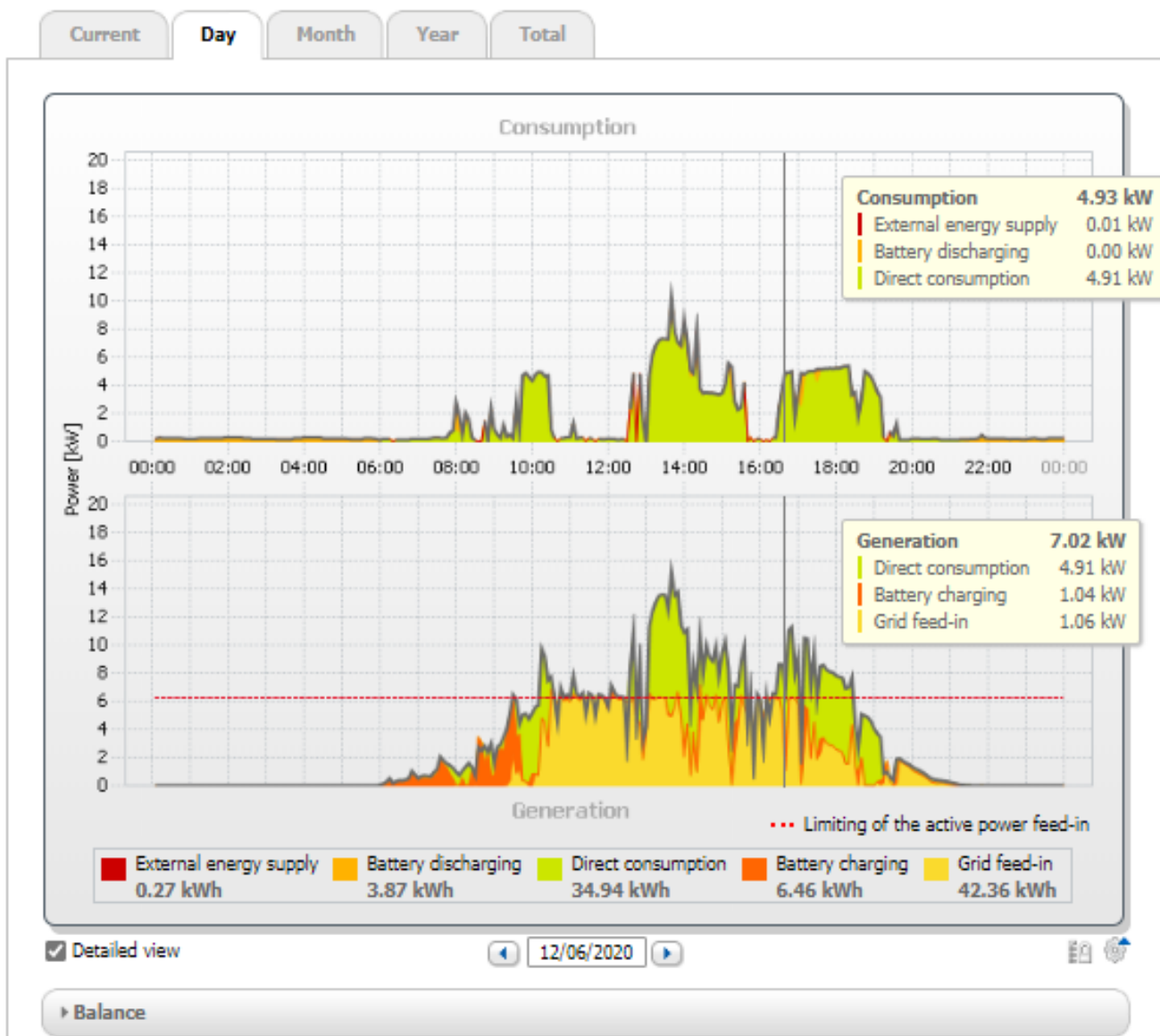

Figure 18: Energy balance of a specific day (example)



### **i** Point in time in the diagram and the corresponding data

If you move the mouse pointer over the diagram, a vertical line is displayed. This line visualizes the position of the mouse pointer on the time axis in the diagram and therefore the selected point in time. The power or energy values of the diagram for this point in time are displayed next to the line.

### Energy consumption and energy generation

Designation	Explanation
Consumption	Power that your household drew from your system (direct consumption or internal power supply for systems without battery), the utility grid (grid-supplied power) and, if applicable, the battery (battery discharging) during the period selected.
Direct consumption*	Power that your household drew and consumed directly from your PV system during the period selected, without intermediate storage in the battery.
Grid-supplied power	Energy that was drawn from the utility grid during the period selected.
Internal power supply	Energy used in the system that did not come from the utility grid, but rather was generated on site. It is made up of directly used PV energy (direct consumption) and stored PV energy (battery discharging). The internal power supply quota describes which proportion of the energy used in the system comes from that generated on site.
yield	Energy that was supplied to your household by your PV system during the period selected.  For systems with battery, the energy comes preferably directly from the system (direct consumption). If the power produced by the system is not sufficient, the remaining power is supplied by discharging the battery.
Self-consumption	PV energy that is used on-site and not fed into the utility grid. It is made up of directly used PV energy (direct consumption) and stored PV energy (battery charging). The self-consumption quota describes which proportion of the PV energy generated on-site has been used on-site.
Grid feed-in	Energy that your PV system fed into the utility grid during the period selected.
Battery discharging*	Energy that your household drew from the battery during the period selected.
Battery charging*	Energy that your PV system stored in the battery during the period selected.
Self-sufficiency quota:	Ratio of energy self-sufficiency to consumption in the period selected
Direct consumption quota*	Current ratio of direct consumption to PV power

\* Only displayed for PV systems with battery

On the tabs **Current** and **Day** the gray envelope curve visualizes the consumption (grid-supplied power and energy self-sufficiency) and the generation (direct consumption and grid feed-in) for the selected period or the selected day.

On the tabs **Month**, **Year** and **Total** the gray envelope curve visualizes the generation (direct consumption and grid feed-in) for the selected period. The envelope curve is only visible if the data are incomplete or cannot be calculated, or if the components of the generation are hidden using the legend below the diagram.

### Limitation of Active Power Feed-In

The dotted red line indicates the maximum active power that may be fed into the utility grid.

- The dotted red line will only be displayed if you have set a limit for active power feed-in for your PV system in the Sunny Home Manager Configuring Limitation of Active Power Feed-In.
- The line is only displayed in the diagrams of the tabs **Current** and **Day**.
- If you have limited the active power feed-in to 0%, the red line runs directly on the x-axis of the diagram. Limitation of the active power feed-in to 0% is only supported by inverters that support the fallback function (fallback: in the event of a communication failure between the Sunny Home Manager and the inverter, the inverter reverts to an output power of 0 watts). For more information see the inverter manual at [www.SMA-Solar.com](http://www.SMA-Solar.com).

The **Legend** below the diagram explains the colors used in the diagram and displays the most important overall values for the time period displayed.

Useful hint: You can show and hide data in the diagram by clicking on the term in the legend.

Useful hint: When you move the mouse pointer over a term in the legend, an explanation of this term is displayed.

Under **Balance**, the calculated values for the self-sufficiency and self-consumption quota, which reflect the type of your own energy supply, as well as other total values for the period shown are displayed.

### Display with Battery

If a battery inverter is present in your system, you can select between the simplified view without battery data and the detailed view with battery data.

To have the battery data in the diagram and in the **Balance** area displayed, you must activate or deactivate the checkbox **Detailed view**.

## 13.5 Load Balance and Control

### 13.5.1 Overview load balance and control

The diagrams and tables on this page provide an overview of operating time, operating duration and energy consumption of the devices automatically controlled by the Sunny Home Manager

#### Requirements for displaying the page:

- In the Sunny Home Manager system, loads must be available and configured which are either connected to radio-controlled sockets or which can be directly controlled by the Sunny Home Manager.

Depending on the tab, the diagram and table show different views and data of the loads:

Tab	Content
Currently	<p><b>The following is required to display the tab Current:</b></p> <ul style="list-style-type: none"> <li>□ The data request interval must be set to <b>Automatic</b> (see Section 11.3.6, page 57).</li> </ul> <p>Use energy meters recommended by SMA. Otherwise there may be a delay in the data being displayed in the Current tab.</p> <p>The tab shows the following current data:</p> <p>In the diagram:</p> <ul style="list-style-type: none"> <li>• Line at the bottom of the diagram: Live data on the flow of the consumed power of each load in the selected display period (slider).</li> </ul> <p>In the table:</p> <ul style="list-style-type: none"> <li>• <b>Operating Mode:</b> Operating mode of the radio-controlled socket The button of the currently selected operating mode is highlighted in color. In addition, the LED status of the radio-controlled socket is displayed via an LED symbol and the current status is explicitly stated. The operating mode can be changed accordingly using the buttons. If the operating mode is controlled via the Sunny Home Manager, <b>(Automatic)</b> appears behind the operating mode. <ul style="list-style-type: none"> <li>- <b>Switch on:</b> The SMA radio-controlled socket is switched on and switches to the operating mode <b>On</b>. The connected load can draw electric current.</li> <li>- <b>Switch off:</b> The SMA radio-controlled socket is switched on and switches to the operating mode <b>Off</b>. The connected load cannot draw electric current.</li> <li>- <b>Automatic:</b> Depending on the current control command of the Sunny Home Manager, the SMA radio-controlled socket is either switched on or off in this mode. (This operating mode cannot be set for the load type <b>Measure only</b>.)</li> </ul> </li> <li>• <b>Current value of consumption:</b> Power currently being drawn by the load</li> <li>• <b>Configuration:</b> With the <b>Configuration</b> button [⚙️] you can configure the properties of the load (e.g. priority).</li> </ul>

Tab	Content
Day	<p>In the diagram:</p> <ul style="list-style-type: none"> <li>• With selected view <b>Stacking order view</b> (☰): The lines below in the diagram show the progression of the power drawn by each load on the selected day. Via the legend below the diagram, you can show and hide the loads displayed in the diagram and change the stacking order of the loads in the diagram: <ul style="list-style-type: none"> <li>- To hide a load, click on the desired load. Loads that have been hidden will be displayed in gray in the legend. You can display the load again by re-clicking on the load.</li> <li>- To show all loads that have been hidden, select <b>Show all</b> below the legend.</li> <li>- To display only the values for battery charging, overall consumption and purchased electricity in the diagram, select <b>Display standard</b> below the legend.</li> <li>- To change the stacking order in the diagram, select the desired load and, holding down the left mouse button, drag it to the desired position in the legend.</li> </ul> </li> <li>• With selected view <b>Time period</b> (☰): The light-colored bars show the time periods which you have configured for the operation of the load. The dark-colored bars show the time periods in which the loads were actually in operation. <ul style="list-style-type: none"> <li>- If you move the mouse pointer over one of the dark-colored bars, the energy consumed by the load in this time period is displayed in kWh.</li> </ul> </li> </ul> <p>In the table:</p> <ul style="list-style-type: none"> <li>• <b>Daily consumption:</b> Energy drawn by the load on the selected day</li> <li>• <b>Configuration</b></li> </ul>
Month	<p>In the diagram:</p> <ul style="list-style-type: none"> <li>• Energy drawn by each load in the selected month in days If you move the mouse pointer over one of the bars in the diagram, a window opens with the following information: <ul style="list-style-type: none"> <li>- The respective daily consumption of the loads operated on that day</li> <li>- The respective percentage of the daily consumption which was covered by PV energy (☼), battery discharging (🔋) or by the utility grid (🏠)</li> </ul> </li> </ul> <p>In the table:</p> <ul style="list-style-type: none"> <li>• <b>Monthly consumption:</b> Energy drawn by the load in the selected month</li> <li>• <b>PV energy percentage:</b> Percentage of the monthly consumption covered by PV energy</li> <li>• <b>Battery discharging percentage:</b> Percentage of the monthly consumption covered by battery discharging*</li> <li>• <b>Purchased electricity percentage:</b> Percentage of the monthly consumption covered by the utility grid</li> <li>• <b>Configuration</b></li> </ul>

Tab	Content
Year	<p>In the diagram:</p> <ul style="list-style-type: none"> <li>• Energy drawn by each load in the selected year in months</li> </ul> <p>In the table:</p> <ul style="list-style-type: none"> <li>• <b>Annual consumption:</b> Energy drawn by the load in the selected year</li> <li>• <b>Battery discharging percentage:</b> Percentage of the annual consumption covered by battery discharging</li> <li>• <b>PV energy percentage:</b> Percentage of the annual consumption covered by PV energy</li> <li>• <b>Purchased electricity percentage:</b> Percentage of the monthly consumption covered by the utility grid</li> <li>• <b>Configuration</b></li> </ul>
Total	<p>In the diagram:</p> <ul style="list-style-type: none"> <li>• Energy drawn by each load in the individual years</li> </ul> <p>In the table:</p> <ul style="list-style-type: none"> <li>• <b>Total consumption:</b> Total energy drawn by the load so far</li> <li>• <b>PV energy percentage:</b> Percentage of the total consumption drawn from PV energy</li> <li>• <b>Battery discharging percentage:</b> Percentage of the total consumption drawn from battery discharging*</li> <li>• <b>Purchased electricity percentage:</b> Percentage of the total consumption drawn from the utility grid</li> <li>• <b>Configuration</b></li> </ul>
control	This tab represents the table of the tab "Current", i.e. identical data are shown; the graphic is missing here compared to the tab "Current".

\* Only displayed for PV systems with battery

Regardless of the selected tab, the column **Configuration** is always shown for each load in the table.

The  symbol takes you directly to the **Load properties** tab (on the load overview and planning page), on which you can configure the properties of the selected load (see Section 11.1.2, page 51).

## 13.5.2 Selecting the Load Display

### Showing and hiding loads

Using the **Legend** below the diagram, you can show and hide the loads displayed in the diagram.

#### Procedure:

1. To hide a load, click on the desired load.
  - Loads that have been hidden will be displayed in gray in the legend.
2. You can display the load again by re-clicking on the load.
3. To show all loads that have been hidden, select **Show all** below the legend.

### Selecting the load color

The loads are displayed in different colors in the diagrams for better visualization. The assigned color can be changed if necessary.

**Procedure:**

- Click on the color square next to the desired load in the list below the diagram and choose a new color from the color palette.

## 13.6 Display of the nominal system power

### 13.6.1 System yield in the annual comparison

The system yields of previous years are compared to each other in a diagram with associated table on the menu page **Annual comparison**. Thus, the system must have been in operation for more than 1 year so that data for an annual comparison can be displayed here.

Tab	Content
Total Yield	<p>In the diagram:</p> <ul style="list-style-type: none"> <li>• Yield development over the previous years</li> <li>• Average yield development over the previous years</li> <li>• Average expected yield*</li> </ul> <p>In the table:</p> <ul style="list-style-type: none"> <li>• Yield values (kWh/kWp) of the previous years and the current year per month as well as added up.</li> <li>• Mean values per month</li> <li>• Proportion year (can only be displayed once a full year has passed)</li> <li>• Expected yield</li> </ul>
Specific system yield	<p>In the diagram:</p> <p>The specific system yield is a key figure for describing the quality of a system. System-specific factors such as location, tilt angle, shading, module and inverter types are taken into consideration to calculate the specific system yield. The specific system yield enables you to compare various systems at various locations.</p> <ul style="list-style-type: none"> <li>• Development of the specific system yield of each previous year</li> <li>• Average development of the specific system yield of the previous years</li> <li>• Average expected yield*</li> </ul> <p>In the table:</p> <ul style="list-style-type: none"> <li>• Specific system yield (kWh/kWp) of the previous years and the current year per month as well as added up.</li> <li>• Mean values per month</li> <li>• Proportion year (can only be displayed once a full year has passed)</li> <li>• Expected yield</li> </ul>

\* The expected average yield results from a manual specification that you can make based on your system's location data. Depending on the orientation and the irradiation fluctuations between the individual years, there might be considerably larger deviations in contrast to the expected average yield.

### Calculation of the expected yield

The button **Edit prediction values** takes you directly to the menu where you enter the specific annual yield and can have the expected annual yield calculated (see Section 10.4.7, page 48).

The **Predicted annual yield** of the PV system is calculated from the specific annual yield (kWh/kWp) at the PV system location and the PV system power (kWp).

You can obtain the specific annual yield for your PV system location from irradiation maps. Local conditions such as shading or the system orientation are not taken into account. You can obtain the nominal system power from your installer.

The **Monthly distribution of the expected annual yield** shows how the expected annual yield is distributed throughout the year. Given complete information about the system location, Sunny Portal can suggest a distribution. For this, click on the button [**Suggest a monthly distribution**].

You may also enter a percentage value for each month (the sum must result in 100%).

You can enter and/or change all data regarding your system in the **Configuration** menu on the **PV system properties** page.

## 13.6.2 Nominal system power analysis

### 13.6.2.1 Overview analysis

On the page **Analysis**, you can compare the power and yield values of individual inverters with one another or with the complete system.



Figure 19: **Analysis** menu page (example)

Position	Explanation
A	<b>Device Selection</b> area
B	Tabs
C	Diagram preview* The diagram preview is divided into sections by lines. If you select a section in the diagram preview, the content is shown in the large diagram.
D	Large diagram Tip: If you move the mouse on to the diagram, the value from the area <b>Details</b> is shown next to the cursor.
E	<b>Total yield</b> or <b>Spec. total yield</b> Depending on the type of display selected in the area <b>Device selection</b> , the total yield or specific total yield will be displayed here.



Position	Explanation
F	<b>Details</b> area This area contains the power values of the displayed diagram as 15-minute mean values.
G	<b>Logbook</b> area This area contains messages from selected devices and associated higher-level system messages.

\* Not shown on the **Total** tab

## Display on the tabs

Tab	Explanation
Day	Diagram preview: <ul style="list-style-type: none"> <li>Preview of diagrams with the progression of the PV system yields for individual days Tip: If you move the cursor over a day in the diagram, the total yield of the PV system for this day is shown.</li> </ul> Large diagram: <ul style="list-style-type: none"> <li>Power value curve as 15-minute mean values of the selected devices for the selected day</li> <li>Bottom right in the diagram*: Total yield of the PV system for the selected day</li> </ul>
Week	Diagram preview: <ul style="list-style-type: none"> <li>Preview of diagrams with the progression of the PV system yields for individual weeks Tip: If you move the cursor over a week in the diagram, the total yield of the PV system for this week is shown.</li> </ul> Large diagram: <ul style="list-style-type: none"> <li>Power value curve as 15-minute mean values of selected devices for the selected week.</li> <li>Bottom right in the diagram*: Total yield of the PV system for the selected week</li> </ul>
Month	Diagram preview: <ul style="list-style-type: none"> <li>Preview of diagrams with the yield values of the PV system for each month in days Tip: If you move the cursor over a month in the diagram, the total yield of the PV system for this month is shown.</li> </ul> Large diagram: <ul style="list-style-type: none"> <li>Yield values of selected devices for the selected month in days</li> <li>Bottom right in the diagram*: Total yield of the PV system for the selected month</li> </ul>
Year	Diagram preview: <ul style="list-style-type: none"> <li>Preview of diagrams with the yield values of the PV system for each year in months Tip: If you move the cursor over a year on a diagram, the total yield of the PV system for this year is shown.</li> </ul> Large diagram: <ul style="list-style-type: none"> <li>Yield values of the selected devices for the selected year in months</li> <li>Bottom right in the diagram*: Total yield of the PV system for the selected year</li> </ul>
Total	Large diagram: <ul style="list-style-type: none"> <li>Yield values of selected devices for individual years</li> <li>Bottom right in the diagram*: Total yield of the PV system for all years together</li> </ul>

\* Only displayed if the checkbox **Complete PV system** is activated in **Device selection**

### 13.6.2.2 Setting the Device Selection

In the **Device selection** area, you can select whether the complete system and/or individual inverters are to be displayed in the large diagram and in the **Details** area. Moreover, you can select whether absolute or specific values are to be displayed.

#### Selecting devices:

1. To display the values of the complete system, activate the checkbox **Complete PV system** in the area **Device selection**.
2. To display the values of individual inverters, perform the following steps:
  - Select the area **Device selection** .
    - The area opens and the individual inverters are displayed.
  - Activate the checkboxes for the desired inverters.  
Tip: If you activate the checkbox **Select all devices**, the checkboxes for all inverters will be activated.

#### Selecting the display type:

- In the area **Device selection**, next to **Display type**, select the desired option:
  - **Absolute**: Shows the system yield (kWh) or the system power (kW).
  - **Specific**: Shows the specific system yield (kWh/kWp) or the specific system power.

## 14 Monitoring of the Sunny Home Manager system

The menu page **PV system monitoring** displays the following information depending on your system's configuration:

- Communication Monitoring
- Inverter comparison
- SMA Smart Connected





Each of these areas can be configured separately via the **[Settings]** button.

### 14.1 Overview of system monitoring

#### 14.1.1 Communication Monitoring

Communication monitoring displays the current communication status between the Sunny Home Manager and Sunny Portal. If the Sunny Home Manager does not communicate with Sunny Portal within the set time, Sunny Portal will display an error and notify you by e-mail.

The communication monitoring status is displayed with the following symbols:

Symbol	Status	Explanation
	Disabled	Communication monitoring is not set.
	OK	Communication with Sunny Portal is OK. The time of last contact is displayed.
	Errors	Communication with Sunny Portal is interrupted. The <b>Details</b> link provides you with detailed information on the time of the last contact. The error will be displayed until it has been rectified. If the error is not corrected, Sunny Portal will send another e-mail reminder each day for up to three days after the first e-mail was sent.
	E-mail reminder is activated	Clicking the bell icon stops the sending of reminder e-mails for the current error. If a new error occurs, the e-mail reminder will be sent again.



#### 14.1.2 Inverter Comparison

**Requirements for displaying the information:**

- The system must contain at least two inverters.

The inverter comparison enables Sunny Portal to recognize possible yield losses. If the specific yield of an inverter differs significantly from the mean yield of all the inverters, Sunny Portal can notify you by e-mail.

Symbol	Status	Explanation
	Disabled	No inverter comparison is active at present.

Symbol	Status	Explanation
	OK	The yields of the monitored inverters are within the configured range. The total yield of all inverters on the last day is displayed.
	Errors	The specific yield is outside the tolerance for at least one monitored inverter. You can access the following information via the <b>Details</b> link: <ul style="list-style-type: none"> <li>• Specific yield of the affected inverters</li> <li>• Average yield value of all monitored inverters</li> </ul>

### 14.1.3 SMA Smart Connected

SMA Smart Connected is a service free of charge from SMA Solar Technology AG that offers the following:

- Automatic inverter monitoring - your inverters are continuously checked for anomalies and errors.
- Automatic proactive notification in the event of a fault - following fault diagnosis and analysis you will be notified immediately via e-mail.
- Automatic replacement process - if the inverter has to be replaced, you will quickly receive a free replacement device.

In order to be able to participate in the Smart Connected program, you must give your approval.

### 14.1.4 Further PV System Monitoring Options

#### System logbook

This menu page **PV system logbook** shows messages regarding the system status. These messages help you to identify disturbances in your PV system, for example.

You can filter messages and confirm that you have read the messages.

 You can find the number of unconfirmed messages right in the menu view of the page system logbook after the colon of the page name.

#### System report

On the menu page **Report** you can have the total yield and the meter changes of your system displayed as a summary table and in a diagram:

#### Daily System Report

- Table with meter change of the total yield for the current day, current month and current year
- Diagram with the development of the meter reading over the individual hours of a day

#### Monthly System Report

- Table with meter change of the total yield for the current month and current year
- Diagram with the development of the meter reading over the individual days of a month

You can have the reports sent by e-mail from Sunny Portal.

#### Machine

On the menu page **Devices** the data of the individual devices are displayed on their own page in clearly arranged diagrams.

- For **PV inverters**:
  - Development of the meter reading (total yield in kWh) over the months of a year

- Development of the meter reading (total yield in kWh and power in kW) over the hours of a day
- For **Battery inverters**:
  - Current battery charging capacity over a selected period

If you require more detailed system monitoring functions and more comprehensive data storage, you have the option of activating additional functions via the SMA Online Store subject to a fee.

## 14.2 Configuring PV System Monitoring

### 14.2.1 Setting Communication Monitoring

The [**Settings**] button lets you select whether you want to monitor the communication between Sunny Portal and your system. If you would like monitoring, you can specify at what interval and how strictly this monitoring should take place.

 Sunny Portal can only display current data of the Sunny Home Manager and switch loads if the data request interval is set to **Automatic**.

#### Requirement:

- You must have the user role **Installer** or **PV System Administrator** (see Section 16.1, page 108).

#### Procedure:

1. In the area **Communication Monitoring**, select [**Settings**].
2. Click the slider below **Alerts** and, holding the left mouse button pressed, set the monitoring strength according to which Sunny Portal is to notify you by e-mail.  
These options can be selected: **off**, **liberal**, **tolerant** and **sharp**.
  - The result of the selected setting (time interval: 15 minutes) is shown in the column **Time**.
3. Enter the e-mail address(es) of the recipient(s) in the text field **Recipient**. If you enter several e-mail addresses, separate these by commas. (Only e-mail addresses already registered in Sunny Portal are authorized.)
4. Activate/deactivate monitoring for devices shown.
5. Click on [**Save**].

#### Setting the data request interval for the Sunny Home Manager:

The interval for the data request can be specified in the menu **Configuration** under **Device overview > Properties > Edit** (see Section 11.3.6, page 57) The options are automatic, hourly or daily.

 The Sunny Home Manager can only request data of the devices that have **Data request activated** (see Section 11.1.4, page 53).

### 14.2.2 Setting the Inverter Comparison

#### Requirements:

- The system must contain at least two inverters.
- You must have the user role **Installer** or **PV System Administrator** (see Section 16.1, page 108).

#### Procedure:

1. In the area **Inverter comparison**, select [**Settings**].
2. Enter the e-mail address of the recipient in the text field **Recipient**. If you enter several e-mail addresses, separate these by commas.
3. The PV array power is preset in the text field **Generator capacity**. Sunny Portal calculates the PV array power based on the nominal power of each inverter.  
You can also enter the PV array power manually or have Sunny Portal calculate it if you have entered information on the strings before (see Section 11.4.4, page 61).

4. In the text field **Tolerance**, enter the permissible tolerance for the inverter's specific yield. This simultaneously sets the deviation of the inverter specific yield from which e-mail notification by Sunny Portal will be triggered.
5. To select an inverter for the inverter comparison, activate the checkbox **Monitoring** in the line of the inverter.
6. Click on **[Save]**.

### 14.2.3 Activating SMA Smart Connected

**i** SMA Smart Connected can only be used in Sunny Portal when this feature is supported by the devices connected to the Sunny Home Manager.

In general, each device can be enabled for Smart Connected, however this must be carried out for each individual device and also for each individual country separately (manually).

In order to be able to participate in the Smart Connected program, you must give your approval. For optimal use of the program, you should also provide the operator and installer data, the delivery address for any replacement that may be required, and the e-mail address of the recipient of the monitoring data.

#### Procedure:

1. In the menu System monitoring click on **[Settings]** in the field SMA Smart Connected.
  - The device properties of the product that supports the SMA Smart Connected function opens.
2. Select **[Edit]**.
3. In the field **SMA Smart Connected** place a checkmark to give approval.
4. Click on **[Save]**.

#### Alternative procedure:

1. Call up the menu page **Configuration > Device overview**.
2. Select the device that supports the SMA Smart Connected function and call up **Properties**.
3. Select **[Edit]**.
4. In the field **SMA Smart Connected** place a checkmark to give approval.
5. Click on **[Save]**.

### 14.2.4 Filter and confirm messages in the system logbook

In the upper area of the page **PV system logbook** there are different fields to filter the messages that are listed in the following table. This filtering only allows you to call up certain messages.

You can confirm messages in order to mark them as read. This will help you to differentiate between old and new messages.

#### Filtering Messages:

1. Select **PV System Logbook** in the page and menu selection.
2. To filter messages, set one or more of the following filters:

Input field or drop-down list	Explanation
-------------------------------	-------------

Go to	The date for the current day is preset. With the arrows on the left and right you can go back any number of days or proceed again. In the table in the column <b>Time</b> all messages up to and including this day are shown.
-------	---

Input field or drop-down list	Explanation
Type	<p>The following message types are available:</p> <ul style="list-style-type: none"> <li>• <b>Information message</b></li> <li>• <b>Warning</b></li> <li>• <b>Event message</b></li> <li>• <b>Error</b></li> <li>• <b>Other</b></li> </ul> <p>To display messages of a specific type, activate the appropriate checkbox(es). The desired messages are displayed in the column <b>Type</b> with the respective symbol and further explained in the column <b>Description</b>.</p>
Status	<p>In the drop-down menu you can either call up all messages or just the ones that are new or that you already read:</p> <ul style="list-style-type: none"> <li>• <b>Not approved</b> messages: new ✖</li> <li>• <b>Approved</b> messages: read ✔</li> <li>• <b>all</b></li> </ul> <p>In the table, the status is displayed in the <b>Confirmed</b> column with the corresponding symbol.</p>
System/Devices	<p>The portal, the system and all devices of your system are listed in the drop-down list.</p> <ul style="list-style-type: none"> <li>• To display the messages in Sunny Portal, the Sunny Home Manager system and the devices, select <b>All</b>.</li> <li>• To only display messages of a specific product, select the respective product (e.g. <b>SB4.0-1A-41</b>).</li> </ul> <p>The selected product can be found in the column <b>PV system/Devices</b> in the table.</p>

### Confirming messages:

#### Requirement:

- You must have the user role **Installer** or **PV System Administrator** (see Section 16.1, page 108).
  1. To confirm individual messages, select ✖ in the required message line and the column **Confirmed**.
  2. To confirm all messages check the checkbox **Confirm all** above the table.

### 14.2.5 Configuring Reports

#### Requirement:

- You must have the user role **Installer** or **PV System Administrator** (see Section 16.1, page 108).

You can configure different types of event reports, each with different content:

Report	Possible content
3 x daily info report	<ul style="list-style-type: none"> <li>Yield (kWh) in the selected time period</li> </ul>
3 x monthly info report	<ul style="list-style-type: none"> <li>Maximum power (kW) in the selected time period</li> <li>CO<sub>2</sub> avoided (kg) in the selected time period</li> <li>Feed-in tariff in the selected time period*</li> <li>Diagram of the page <b>Energy balance</b> for the selected time period (only with PDF delivery)</li> </ul>
3x event report	<ul style="list-style-type: none"> <li>Information</li> <li>Warnings</li> <li>Disturbances</li> <li>Error</li> </ul>
1x event report for standard	<p>Message regarding grounding errors, residual current and the grid disconnecting device</p> <ul style="list-style-type: none"> <li>AS 5033</li> <li>DIN EN 62109-2 / IEC 62109-2</li> </ul>

\* If applicable

In addition, you can create a report for a specific date in the past.

## Configuring Info Reports

Sunny Portal sends you the Daily info reports when it has processed all the data from the previous day, and the Monthly info report at the end of the month.

### Requirement:

- You must have entered the CO<sub>2</sub> avoided factor (see Section 10.4.6, page 47).

### Procedure:

- In the drop-down list **Report Configuration**, select a **Daily info report** or a **Monthly info report**.
- Select **[Edit]**.
- Configure the report:

Range	Explanation
Activate report	<ul style="list-style-type: none"> <li>Activate the checkbox <b>Active</b>.</li> </ul>
Recipient	<ul style="list-style-type: none"> <li>Enter the e-mail address(es) of the recipient(s) in the text field <b>E-mail address(es)</b>. If you enter several e-mail addresses, separate these by commas.</li> </ul>
Content	<ul style="list-style-type: none"> <li>In the area <b>Select channel(s)</b>, activate the content that is to be displayed in the e-mail.</li> <li>In the area <b>Send report as</b>, select the format in which Sunny Portal is to send the report. If Sunny Portal is to send a Sunny Portal page along with the report, select a page in the drop-down list in the area <b>Portal Page to Be Sent</b>.</li> <li>If Sunny Portal is not to send a Sunny Portal page along with the report, select <b>Send no page</b>.</li> </ul>



4. To send a test report to the stated e-mail address, select [**Send test report**].
5. Click on [**Save**].

## Configuring Event Reports

Sunny Portal sends you the event reports at the times set.

### Procedure:

1. In the drop-down list **Report configuration**, select an **Event report**.
2. Select [**Edit**].
3. Configure the report:

Range	Explanation
Activate report	<ul style="list-style-type: none"> <li>• Activate the checkbox <b>Active</b>.</li> </ul>
Recipient	<ul style="list-style-type: none"> <li>• Enter the e-mail address(es) of the recipient(s) in the text field <b>E-mail address(es)</b>. If you enter several e-mail addresses, separate these by commas.</li> </ul>
Interval	<ul style="list-style-type: none"> <li>• To receive an e-mail with event report every hour, activate the option <b>Hourly</b>.</li> <li>• To receive one e-mail with event report per day, activate the option <b>Daily</b> and, in the drop-down list, select the time you would like to receive the e-mail.</li> </ul>
Content	<p>You can select up to four Sunny Portal and Sunny Home Manager system event types: <b>Information, Warnings, Failures, Errors</b>.</p> <ul style="list-style-type: none"> <li>• Activate the content that is to be displayed in the e-mail.</li> <li>• In the area <b>Send report as</b> select the format in which Sunny Portal is to send the report: text, HTML format or PDF.</li> <li>• In the area <b>Limit messages in one report</b>, use the drop-down list to select the maximum number of messages to be displayed in the e-mail.</li> <li>• If you wish to send reports even if there are no new events, activate <b>Send empty reports if no new events are available</b>.</li> </ul>

4. To send a test report to the stated e-mail address, select [**Send test report**].
5. Click on [**Save**].

## Manually Regenerating Reports

You can create a report for a specific date in the past.

### Procedure:

1. Select the desired report in the drop-down list **Report configuration**.
2. In the field **Report date** in the area **Regenerate report manually**, enter the date for which you wish to create a report, either manually or using the calendar.
3. Select [**Generate**].
  - A message that the report has been successfully sent is displayed.

## 15 Presentation of the Sunny Home Manager system

### 15.1 PV System Profile

Sunny Portal compiles the PV system profile from information that you can enter or have entered in different Sunny Portal pages. Thus, the system profile is extensive.

Basically, the profile shows your system's data in three fields, a system image (optional) in another field to the right of it and, if you configure or have configured this, a summary description in a text block below these fields.

The following information can be displayed in the PV system profile:

Position	Information
Field on top	<ul style="list-style-type: none"> <li>• Location</li> <li>• Operator (optional)</li> <li>• Commissioning</li> </ul>
Field center	<ul style="list-style-type: none"> <li>• Nominal system power</li> <li>• Annual production</li> <li>• CO<sub>2</sub> avoided</li> <li>• Nominal battery capacity (only displayed for PV systems with battery)</li> <li>• Battery type (only displayed for PV systems with battery)</li> </ul>
Field bottom	<ul style="list-style-type: none"> <li>• Communication - Sunny Portal receives this information from the devices.</li> <li>• Modules (optional)</li> <li>• Inverter (optional)</li> </ul>
Field on the right	Image of e.g. the system (optional)
Text block	System description (optional)

You can change the individual data in the system profile at any time System Properties.

You can make the system profile available for viewing to third parties and incorporate it in your own web presence Make PV system profile publicly available.

### 15.2 Make PV system profile publicly available

You can make the system profile available for viewing to third parties and incorporate it in your own web presence.

On the menu page **PV system presentation** the source text is shown in the field **PV system profile**.

Clicking on the button **[Preview]** displays the stored PV system profile. You can incorporate this PV system profile in your web presence by copying and pasting the source text into your web presence.

Changes to your PV system profile can be made in **Configuration** under **PV system properties > PV system data** (see Section 10.1, page 40).

### 15.3 Releasing and publishing pages

With Sunny Portal you can present your PV system to third parties.

- You can make selected Sunny Portal pages of your PV system available for viewing on sunnyportal.com and send links on these pages by e-mail to interested persons.
- You can set a link to your Sunny Portal page on other websites.

The following Sunny Portal pages can be selected for release or for linking:

- System profile
- System overview

- Annual comparison

**Requirement:**

- You must have the user role **Installer** or **PV System Administrator** (see Section 16.1, page 108).

**Releasing Pages for Viewing in Sunny Portal**

- You must have published at least one page.

**Procedure:**

1. In the field **Publicly available area** click on the link **Open publicly available area of this PV system** to see which pages you have released so far (usually at least the PV system profile).
2. Click on the button [**Send the website by e-mail**].
3. Enter the e-mail address of the recipient and (optional) a message for the recipient.
4. [**Send e-mail**].

**Presenting Sunny Portal Pages on the Internet**

Each of your Sunny Portal pages has its own URL. Using these URLs, you can set a link to your Sunny Portal page on other websites.

**Procedure:**

1. Select the desired page in the page and menu selection.
2. In the contents area, select [**Configuration - "Name of the page"**].
3. To view a preview of the page, select **Open page in a new window**.
4. Copy the URL from the **URL of the Page** field onto the clipboard.
5. Copy the URL from the clipboard to a program for creating websites (e.g. Microsoft Office Frontpage) or integrate it into your own website by means of an inline frame.

## 15.4 Specifying the System Home Page

In the field **System home page** you can specify which Sunny Portal page is to be displayed first for your PV system upon login or after switching PV systems.

1. From the drop-down menu select one of the menu pages of your Sunny Home Manager system as the home page.
2. Click on [**Save**].

## 16 User Management

### Requirements for displaying the page:

- You must be a **System administrator**.

This page displays all users created for the Sunny Home Manager system (see Section 16.2, page 109). You can also edit previously created users and, for example, change the user roles or delete users.

### 16.1 User Groups and User Rights

If you have the user role **PV system administrator**, you can create further users in Sunny Portal so that they have access to your Sunny Portal system. You can assign various roles to users. The roles are differentiated by the rights they grant to users in your Sunny Portal system. The following roles are possible:

- Guest
- Standard user
- Installer
- System administrator

Rights	Role			
	Guest	Standard user	Installer	PV system administrator
Log in	✓	✓	✓	✓
View pages	✓	✓	✓	✓
Change and delete pages	–	–	✓	✓
Release pages for viewing in Sunny Portal and publish pages	–	–	✓	✓
View live data	–	✓	✓	✓
Save diagram data	–	✓	✓	✓
View and change user information	✓	✓	✓	✓
Changing the Sunny Portal Password	–	✓	✓	✓
Change system password	–	–	✓	✓
View and read out device properties	–	✓	✓	✓
Change device properties	–	–	✓	✓
View system properties	–	✓	✓	✓
Change system properties	–	–	✓	✓
View report configuration	–	✓	✓	✓
Change report configuration	–	–	✓	✓
Add radio-controlled sockets	–	✓	✓	✓

Rights	Role			
	Guest	Standard user	Installer	PV system administrator
Configure radio-controlled sockets	–	✓	✓	✓
Set the operating mode of radio-controlled sockets via Sunny Portal	–	✓	✓	✓
Replace Sunny Home Manager	–	–	✓	✓
Delete Sunny Home Manager	–	–	✓	✓
Reassign the Sunny Home Manager to the system	–	–	✓	✓
Delete the Sunny Home Manager system	–	–	–	✓
Add devices	–	–	✓	✓
Replace devices	–	–	✓	✓
Delete devices	–	–	✓	✓
Set communication monitoring	–	–	✓	✓
Set inverter comparison	–	–	✓	✓
View the PV system logbook	–	✓	✓	✓
Confirm entries in the PV system logbook	–	–	✓	✓
Import data	–	–	✓	✓
Read off the software package version	–	✓	✓	✓
View user management	–	–	–	✓
Create and delete users and assign roles	–	–	–	✓

## 16.2 Creating a New User

### Procedure:

1. Select **Configuration > User management** in the page and menu selection.
  2. Select [**New User**].
  3. Enter the e-mail address of the new user in the text field **E-mail address**.
  4. Activate the desired role option in the area **Roles**.
  5. Click on [**Save**].
- The new user receives an e-mail with the access data.

## 16.3 Deleting a User

### Procedure:

1. Select **Configuration > User management** in the page and menu selection.
2. In the user line and the column **Delete**, select .
3. Confirm the security prompt with **[Yes]**.

## 16.4 Changing User Rights

### Procedure:

1. Select **Configuration > User management** in the page and menu selection.
  2. In the user line and the column **Edit**, select 
    - The areas **E-mail Address** and **Roles** open.
  3. Activate the desired role option in the area **Roles**.
  4. Click on **[Save]**.
- The user rights are changed for the Sunny Home Manager system.

## 16.5 Changing User Information

Every user can enter user information. User information includes, for example, the user's name and address.

### Procedure:

1. Select **User Info/Logout > User information** in the page and menu selection.
2. Select **[Edit]**.
  - The menu for setting user information opens.
3. Enter the user information.
4. Click on **[Save]**.

## 17 Password Information

### 17.1 Requirements for a Secure System Password

Rules to increase the security of your password:

Select passwords containing at least 10 characters and a maximum of 50 characters, including

- at least a lowercase letter
- at least an uppercase letter
- at least a digit and
- at least one of the following permitted special characters: (!\"#\$%&/()=?\*+'#\_.,;<>|{[]}]^`°)

### 17.2 Required Passwords

#### Sunny Portal password

If you register a PV system in Sunny Portal, you must specify a Sunny Portal password during registration which you will use to log in to Sunny Portal.

If you have registered as a new user in Sunny Portal (see Section 16.2, page 109), you will receive an e-mail with a Sunny Portal password.

You can change the Sunny Portal password (see Section 17.3, page 112).

#### System Password

All devices connected via Speedwire with the same password form a system. For this reason, a password used for all devices in a system is called a system password. The system-specific password protects a system's communication.

You can only access the devices in your PV system via your communication product if all devices have the same password.

You must define the system password in Sunny Portal when you register the Sunny Home Manager system. The system password that you defined upon registration of the Sunny Home Manager is the password of the user group **Installer**. You can change the system password (see Section 17.3, page 112).

#### Password for Edimax radio-controlled sockets

The same password must be used for all Edimax radio-controlled sockets in the system that require a password. If there are different passwords for the radio-controlled sockets, the Sunny Home Manager cannot control all radio-controlled sockets.

Make sure that the shared password is entered at the following positions:

- In the separate Edimax app for each radio-controlled socket registered there
- In the Sunny Home Manager properties (see Section 11.3.4, page 57)

#### FRITZ!Box password

There is no separate password for AVM radio-controlled sockets. The communication of the Sunny Home Manager with the AVM radio-controlled sockets FRITZ!DECT 200 and FRITZ!DECT 210 occurs indirectly via the FRITZ!Box. For this, a FRITZ!Box password is required depending on the set login (see Section 11.3.3, page 56).

Make sure that the settings for the FRITZ!Box login in the home network are the same in the FRITZ!Box and in the Sunny Home Manager.

## 17.3 Changing Passwords

### Changing the Sunny Portal Password

#### Requirements:

- You must be a **Standard user, Installer** or **PV system administrator** (see Section 16.1, page 108).

#### Sunny Portal password requirements:

- The Sunny Portal password must at least consist of 10 characters and have a maximum of 50 characters. The strict rules previously stated apply (see Section 17.1, page 111).

#### Procedure:

1. Select **User Info/Logout > Personal data** in the page and menu selection.
2. On the tab **Personal data**, select the hyperlink **If you want to change your password, please click here**.
3. Enter the old and the new Sunny Portal passwords in the designated text fields.
4. Click on [**Save**].

### Change system password

#### Requirement:

- You must have the user role **Installer** or **PV System Administrator** (see Section 16.1, page 108).

#### System password requirements:

The system-specific system password must consist of at least 8 characters and no more than 12 characters, including

- at least a lowercase letter
- at least an uppercase letter
- at least a digit and
- at least one of the following permitted special characters: ? \_ ! -

#### Procedure:

1. Call up the device properties of the Sunny Home Manager (see Section 11.3, page 55).
2. Select [**Edit**].
  - The menu for setting the device properties opens.
3. Enter a new password in the **PV system password** field.
4. Enter the new password again in the field **Repeat password**.
5. Click on [**Save**].
  - The Sunny Home Manager changes the password for all devices.

## 17.4 Procedure in Case of Forgotten Passwords

### Sunny Portal Password Forgotten

1. Go to **www.sunnyportal.com**.
2. In the **Login** area, select the **Forgotten password** link.
3. Enter your e-mail address in the **E-mail** field.
4. Select [**Generate New Password**].
  - You will receive an e-mail with a new password.
5. Change the assigned password (see Section 17.3, page 112).



### **System Password Forgotten**

Activate each device with a personal unlocking key (PUK).

### **Forgotten password for Edimax Wi-Fi radio-controlled sockets**

See manufacturer's manual.

### **Forgotten password for the Fritz!Box**

See manufacturer's manual.

## 18 Troubleshooting

### 18.1 Error messages general

Problem	Causes and remedies
<p>In my system, there were communication problems due to an internet failure. Are all generation data lost for the time of the failure?</p>	<p>The data is not lost. With a maximum of 24 connected devices, the Sunny Home Manager 2.0 can bridge a period of approx. 5 days without data loss in the event of an Internet connection failure. If less equipment is installed, the period is proportionally extended.</p>
<p>The Home Manager has switched off a load during operation.</p>	<p>The Home Manager learns how long a load's program takes. If another device with a longer program runtime is used, the Home Manager switches off the load during operation.</p> <p><b>Corrective measures:</b></p> <p>Manually switch the load to automatic mode if the program is running for a longer period of time.</p>
<p>The Home Manager does not detect any devices.</p>	<p>The devices must be connected to the local router via Ethernet/Wi-Fi and also be able to communicate with the Sunny Home Manager:</p> <p><b>Corrective measures:</b></p> <ul style="list-style-type: none"> <li>• All Ethernet/Wi-Fi devices in your PV system must be in operation.</li> <li>• The Ethernet/Wi-Fi devices must be connected to the router/network switch correctly.</li> <li>• The network cable connecting the Ethernet devices with the router/network switch must be suitable for 100 MBit/s.</li> <li>• The Ethernet devices must be in the same local network as the Home Manager.</li> <li>• DHCP must be activated on the router.</li> <li>• The router must have an Internet connection.</li> <li>• For Ethernet devices with integrated Bluetooth interface, the NetID of 0 must be set. In this way, Bluetooth is deactivated.</li> <li>• The LAN ports on the router / network switch may not be switched off in the event of apparent inactivity (see router / network switch manual).</li> <li>• The network switch may not use IGMP snooping (see network switch manual).</li> </ul>
<p>Device updates are not being loaded.</p>	<p>Some devices can only get their update directly since the update file is too large.</p> <p><b>Corrective measures:</b></p> <ul style="list-style-type: none"> <li>• Check the status or event messages of the affected device. If necessary, perform a manual device update (as per the device manual).</li> </ul>
<p>Device parameters are not updated.</p>	<p>It is possible that the device cannot be accessed.</p> <p><b>Corrective measures:</b></p> <ul style="list-style-type: none"> <li>• Try to manually update the device parameters (see Section 11.1, page 50).</li> </ul> <p>The system password may be incorrect.</p> <p><b>Corrective measures:</b></p> <ul style="list-style-type: none"> <li>• Enter the correct password.</li> </ul>

## 18.2 Errors during Registration in Sunny Portal

Problem	Cause and corrective measures
The system setup assistant cannot establish a connection to the Sunny Home Manager.	<p>It is possible that the Sunny Home Manager is not correctly connected to the router.</p> <p><b>or</b></p> <p>It is possible that the Sunny Home Manager is not connected to the voltage supply. In this case, all LEDs on the Sunny Home Manager will be off.</p> <p><b>Corrective measures:</b></p> <ul style="list-style-type: none"> <li>• Ensure that the Sunny Home Manager is correctly connected to the router (see Section 8.3.2 "Connecting the Sunny Home Manager to the Router", page 28).</li> <li>• Ensure that the Sunny Home Manager is supplied with voltage.</li> <li>• If the Sunny Home Manager is correctly connected to the router and is supplied with voltage but all LEDs remain off, contact the Service (see Section 22, page 130).</li> </ul>
	<p>It is possible that the SMA device is not correctly connected to the router or is not supplied with voltage.</p> <p><b>Corrective measures:</b></p> <ul style="list-style-type: none"> <li>• Ensure that the SMA device is correctly connected to the router and is supplied with voltage (see SMA device documentation).</li> </ul>
	<p>The SMA device is already registered in Sunny Portal via Webconnect.</p> <p><b>Corrective measures:</b></p> <ul style="list-style-type: none"> <li>• Delete the SMA device from the Webconnect system or deactivate the data reception of the device in the Webconnect system.</li> </ul>
	<p>The SMA device is not located in the same local network as the Sunny Home Manager.</p> <p><b>Corrective measures:</b></p> <ul style="list-style-type: none"> <li>• Connect the SMA device to the same router/network switch as the Sunny Home Manager.</li> </ul>

Problem	Cause and corrective measures
The system setup assistant cannot establish a connection to the Sunny Home Manager.	<p>The network cable that connects the SMA device to the router/network switch is not suitable for 100 MBit/s.</p> <p><b>Corrective measures:</b></p> <ul style="list-style-type: none"> <li>• Use a network cable suitable for Speedwire (for network cable requirements, see the Speedwire device documentation).</li> </ul> <hr/> <p>DHCP is not activated in your router.</p> <p><b>Corrective measures:</b></p> <ul style="list-style-type: none"> <li>• Activate DHCP in the router.</li> <li>• If your router does not support DHCP, configure the static network settings on the Speedwire device using SMA Connection Assist. You can obtain the SMA Connection Assist software free of charge from the download area at <a href="http://www.SMA-Solar.com">www.SMA-Solar.com</a>.</li> </ul> <hr/> <p>The router/network switch used in the network deactivates the LAN ports when they appear to be inactive in order to save energy. As a result, it is not possible to establish any connection to the SMA device.</p> <p><b>Corrective measures:</b></p> <ul style="list-style-type: none"> <li>• Configure the router/network switch so that the LAN ports are not deactivated.</li> </ul>
The system setup assistant lists none or not all of the new SMA devices that are connected via Speedwire/Ethernet.	<p>The network switch used in the network uses IGMP snooping. This means that the connection to the SMA device is interrupted due to apparent inactivity, and cannot be subsequently restored.</p> <p><b>Corrective measures:</b></p> <ul style="list-style-type: none"> <li>• Deactivate the "IGMP snooping" function in the network switch if this is possible. Otherwise, replace the network switch.</li> </ul> <hr/> <p>The firewall or IP filter may not have been configured correctly.</p> <p><b>Corrective measures:</b></p> <ul style="list-style-type: none"> <li>• Adjust the firewall or IP filter settings (see firewall- or router documentation).</li> </ul>
The system setup assistant cannot find any Sunny Home Manager with the entered identification and registration ID.	<p>The serial number and/or the registration ID may have been entered incorrectly.</p> <p><b>Corrective measures:</b></p> <ul style="list-style-type: none"> <li>• Ensure that the entries are correct.</li> </ul> <hr/> <p>It is possible that the registration procedure was previously initiated but not completed.</p> <p><b>Corrective measures:</b></p> <ul style="list-style-type: none"> <li>• Perform a complete reset of the Sunny Home Manager (see Section 11.6.1, page 64).</li> </ul>

Problem	Cause and corrective measures
<p>The system setup assistant cannot find any Sunny Home Manager with the entered identification and registration ID.</p>	<p>It is possible that the Sunny Home Manager is not properly connected to the router.</p> <p><b>Corrective measures:</b></p> <ul style="list-style-type: none"> <li>• Ensure that the Sunny Home Manager is correctly connected to the router (see Section 8.3.2 "Connecting the Sunny Home Manager to the Router", page 28).</li> </ul> <hr/> <p>DHCP is possibly not activated on your router or there is a proxy server in your network. For this reason, Sunny Home Manager cannot establish a connection to Sunny Portal.</p> <p><b>Corrective measures:</b></p> <ul style="list-style-type: none"> <li>• Establish the connection to Sunny Portal using the Sunny Home Manager Assistant (see Section 18.6.1 "Using the Sunny Home Manager Assistant in case of network problems", page 122).</li> </ul> <hr/> <p>The Sunny Home Manager has already been assigned to a system in Sunny Portal with your e-mail address.</p> <p><b>Corrective measures:</b></p> <ul style="list-style-type: none"> <li>• Delete the Sunny Home Manager from the PV system (see Section 11.7, page 65).</li> </ul> <hr/> <p>The Sunny Home Manager is assigned to a different system in Sunny Portal, for instance, if you have bought the Sunny Home Manager second-hand.</p> <p><b>Corrective measures:</b></p> <ul style="list-style-type: none"> <li>• If possible, contact the previous owners and ask them to delete the Sunny Home Manager system in Sunny Portal.</li> </ul>
<p>After you have entered the system password and added devices, some devices are shown with a warning symbol in the system setup assistant.</p>	<p>There is a different installer password configured in the devices with warning symbols.</p> <p><b>Corrective measures:</b></p> <ol style="list-style-type: none"> <li>1. Select [<b>Skip forward</b>] in the system setup assistant and finish registration without selecting the devices.</li> <li>2. Set a uniform installer password for all devices via the inverter user interface.</li> <li>3. If you do not know the password set on each device, apply for a Personal Unlocking Key (PUK) for each device from the Service (see Section 22, page 130).</li> <li>4. Enable each device with the corresponding PUK. Then set a uniform installer password in all devices.</li> <li>5. Log in to Sunny Portal and add the devices to the Sunny Home Manager system as new devices using the configuration wizard (see the user manual "Sunny Home Manager in Sunny Portal").</li> </ol>

Problem	Cause and corrective measures
While the system setup assistant is performing the device search, the status LED of the Sunny Home Manager first flashes red for one to two minutes. Subsequently, the status LED glows green again.	<p>Device detection takes a few minutes longer.</p> <p><b>Corrective measures:</b></p> <ul style="list-style-type: none"> <li>• No measures required.</li> </ul>
The automatic firmware update is not working and there is a corresponding error message.	<p>The Sunny Home Manager may not be able to establish a connection to the SMA Update Portal because there is a proxy server in your network.</p> <p><b>Corrective measures:</b></p> <ul style="list-style-type: none"> <li>• Configure the settings of your network in such a way that the SMA Update Portal <a href="https://Update.SunnyPortal.de">https://Update.SunnyPortal.de</a> can be reached.</li> </ul>

### 18.3 Error message on the Sunny Home Manager

LED status	Cause and corrective measures
Status LED: off	<p>The Sunny Home Manager is not supplied with voltage.</p> <p><b>Corrective measures:</b></p> <ul style="list-style-type: none"> <li>• Connect the Sunny Home Manager to the voltage supply Supplying the Sunny Home Manager with Voltage.</li> </ul>
Status LED: flashing red	<p>The Sunny Home Manager cannot establish the connection to Sunny Portal automatically.</p> <p><b>Corrective measures:</b></p> <ul style="list-style-type: none"> <li>• Use the Sunny Home Manager Assistant (see Section 18.6.1, page 122).</li> </ul>
Performance LED: off	<p>The Sunny Home Manager has not been registered in Sunny Portal yet.</p> <p><b>Corrective measures:</b></p> <ul style="list-style-type: none"> <li>• Register the Sunny Home Manager in Sunny Portal Registering in Sunny Portal.</li> </ul> <p>If the Sunny Home Manager is used as an energy meter, it does not have to be registered - and the performance LED never glows.</p>
Performance LED: glowing red	<p>The Sunny Home Manager cannot establish the connection to Sunny Portal automatically. One or several of the devices in the system is/are in a fault state. This could not be reported yet to Sunny Portal due to the connection failure.</p> <p><b>Corrective measures:</b></p> <ul style="list-style-type: none"> <li>• Check connection and configuration of all devices in the system.</li> </ul>
Performance LED: flashing red	<p>The Sunny Home Manager cannot establish the connection to Sunny Portal automatically.</p> <p><b>Corrective measures:</b></p> <ul style="list-style-type: none"> <li>• Ensure that the Sunny Home Manager is correctly connected to the router (see Section 8.3.2 "Connecting the Sunny Home Manager to the Router", page 28).</li> <li>• Use the Sunny Home Manager Assistant (see Section 18.6.1, page 122).</li> </ul>

## 18.4 Problems when Configuring and Controlling Radio-Controlled Sockets

Problem	Cause and corrective measures
When configuring the radio-controlled sockets, the time period cannot be set as desired.	<p>The time period must be at least as long as</p> <ul style="list-style-type: none"> <li>• the maximum program runtime</li> </ul> <p><b>or</b></p> <p>the sum of the minimum switch-on time and the minimum switch-off time and the sum of the device operating time and the minimum switch-off time set for the time period.</p> <p><b>Corrective measures:</b></p> <ul style="list-style-type: none"> <li>• When setting the time period, take into consideration the maximum program runtime or the minimum switch-on and switch-off time and the set device operating time.</li> </ul>
You can not configure the radio-controlled sockets in Sunny Portal or set the operating mode of the radio-controlled sockets using Sunny Portal.	<p>You do not have <b>Installer</b> or <b>Plant Administrator</b> user rights.</p> <p><b>Corrective measures:</b></p> <ul style="list-style-type: none"> <li>• Ask the system administrator to assign you <b>Installer</b> or <b>Plant administrator</b> user rights (see Section 16.4, page 110).</li> </ul>
The Sunny Home Manager cannot control the Edimax smart plug switch.	<p>The password of the Edimax smart plug switch is unknown to the Sunny Home Manager.</p> <p><b>Corrective measures:</b></p> <ul style="list-style-type: none"> <li>• Enter the password of the Edimax smart plug switch in the Sunny Home Manager properties (see Section 11.3.4, page 57).</li> </ul>
The Edimax smart plug switch registered in the local network is not found by the Sunny Home Manager.	<p>This is a smart plug switch by Edimax, which is not supported by the Sunny Home Manager.</p> <p><b>Corrective measures:</b></p> <ul style="list-style-type: none"> <li>• Check whether the smart plug switch by Edimax is supported by the Sunny Home Manager (see Section 000, page 000).</li> </ul>
The Home Manager is not communicating with the Fritz!Box.	<p>The smart home settings in the Fritz!Box are not correct.</p> <p><b>Corrective measures:</b></p> <ul style="list-style-type: none"> <li>• If you selected the option <b>Login without password</b> for the Fritz!Box login when you set up the smart home control, in the Fritz!Box itself under the tab <b>Login for access from the home network</b> the option <b>Login with keystroke</b> must not be activated.</li> </ul>
The Sunny Home Manager is not able to switch my AVM radio-controlled socket.	<p>In the settings of the FRITZ!Box, it is specified that the radio-controlled socket can be switched via smart home devices.</p> <p><b>Corrective measures:</b></p> <ul style="list-style-type: none"> <li>• Check whether the settings in Sunny Portal match the settings for login of the FRITZ!Box.</li> <li>• In the Fritz!Box settings, select the respective device under <b>Home network &gt; Smart home &gt; Smart home devices</b> and click on the button for editing the properties. Got to <b>Manual switching</b> and enable the <b>Permit manual switching by phone, app, user interface or other smart home device</b> checkbox.</li> </ul>

Problem	Cause and corrective measures
The Sunny Home Manager cannot establish a connection to the AVM radio-controlled sockets.	<p>The TR-064 interface of the FRITZ!Box is disabled.</p> <p><b>Corrective measures:</b></p> <ul style="list-style-type: none"> <li>The interface TR-064 must be enabled in the FRITZ!Box under network settings: Select <b>Home network &gt; Home network overview &gt; Network settings</b> in the FRITZ!Box settings. Then enable the <b>Allow access for applications</b> option under Home network share (see manufacturer manual).</li> </ul>
The Sunny Home Manager switches my AVM radio-controlled socket even though this is not configured in Sunny Portal.	<p>An automatic switching program is stored in the FRITZ!Box.</p> <p><b>Corrective measures:</b></p> <ul style="list-style-type: none"> <li>Delete all automatic switching programs.</li> </ul> <p>The socket has assumed a predefined state due to a restart, for example.</p> <p><b>Corrective measures:</b></p> <ul style="list-style-type: none"> <li>After a restart, configure the switching state of the AVM radio-controlled socket to "Last state".</li> </ul>

## 18.5 Incomplete/Outdated/Faulty Data on the User Interface

Problem	Cause and corrective measures
The page <b>Energy Balance</b> is not displayed.	<p>The <b>Energy balance</b> page is only displayed if the integrated measuring device or a separate SMA Energy Meter supplies measurement data from the grid-connection point.</p> <p><b>Corrective measures:</b></p> <ul style="list-style-type: none"> <li>Ensure that a measuring device is installed at the grid-connection point. Assign the measuring device (integrated or separate SMA Energy Meter) to the point of interconnection in the Sunny Home Manager properties (see Section 11.3.9, page 59).</li> </ul>
On the pages <b>Energy balance</b> and <b>Load balance and control</b> , the <b>Current</b> tab is not displayed.	<p>The tab is only displayed if the data request interval is set to <b>Automatic</b>.</p> <p><b>Corrective measures:</b></p> <ul style="list-style-type: none"> <li>Set the data request interval to <b>Automatic</b> (see Section 11.3.6, page 57).</li> </ul>
The diagrams are empty or incomplete.	<p>No energy meters or not all energy meters are connected to the Sunny Home Manager or they are not configured.</p> <p><b>Corrective measures:</b></p> <ul style="list-style-type: none"> <li>Connect the energy meters to the Sunny Home Manager and configure (see Section 9.1.4, page 32).</li> </ul> <p>Sunny Portal cannot receive any data from the Sunny Home Manager.</p> <p><b>Corrective measures:</b></p> <ul style="list-style-type: none"> <li>Make sure that the connection between the Sunny Home Manager and the Sunny Portal is established (see Section 8.3, page 28).</li> </ul>



Problem	Cause and corrective measures
<p>Data on the following pages is not up to date:</p> <ul style="list-style-type: none"> <li>• <b>Current Status And Forecast</b></li> <li>• <b>Energy balance</b> on the <b>Current</b> tab</li> <li>• <b>Load balance and control</b> on the <b>Current</b> tab</li> </ul>	<p>Settings in the router prevent Sunny Portal from requesting current data from the Sunny Home Manager.</p> <p><b>Corrective measures:</b></p> <ul style="list-style-type: none"> <li>• Ensure that the following requirements are fulfilled <ul style="list-style-type: none"> <li>- All UDP ports &gt; 1024 on the router or modem must be open for outgoing connections. If there is a firewall installed on the router or modem, you may need to adjust the firewall rules.</li> <li>- It must be possible for the outgoing router or modem connections to reach all Internet destinations (target IP, target port). If there is a firewall installed on the router or modem, you may need to adjust the firewall rules.</li> <li>- On the router or modem with NAT (Network Address Translation) there must not be any port forwarding. Potential communication problems can thus be prevented.</li> <li>- There must be no packet filtering or manipulation for SIP packets installed on the router or modem.</li> </ul> </li> </ul>
<p>An exclamation mark is permanently displayed after parameters have been changed.</p>	<p>Sunny Portal could not transfer the parameters to the Sunny Home Manager.</p> <p><b>Corrective measures:</b></p> <ul style="list-style-type: none"> <li>• Make sure that the connection between the Sunny Home Manager and the Sunny Portal is established (see Section 8.3, page 28).</li> </ul>
<p>Sunny Portal is displaying unrealistic data.</p>	<p>The integrated measuring device of the Sunny Home Manager or the separate SMA Energy Meter is not correctly connected or configured.</p> <p><b>Corrective measures:</b></p> <ul style="list-style-type: none"> <li>• Ensure that all devices are correctly connected and configured.</li> </ul>
<p>Sunny Portal is not showing any weather forecast in the diagram <b>Forecast and recommended action</b>.</p>	<p>It can take up to 24 hours after the Sunny Home Manager has been initially registered in Sunny Portal until the weather forecast is displayed.</p> <p><b>Corrective measures:</b></p> <ul style="list-style-type: none"> <li>• After 24 hours, check again to see whether the weather forecast is displayed.</li> <li>• If after 24 hours there is still no weather forecast displayed, contact the Service team (see Section 22, page 130).</li> </ul>
<p>The animated graphic on the page <b>Current status and Forecast</b> is not displaying any current data.</p>	<p>The reception of current data from the Sunny Home Manager is only possible if the data request interval is set to <b>Automatic</b>.</p> <p><b>Corrective measures:</b></p> <ul style="list-style-type: none"> <li>• Set the data request interval to <b>Automatic</b> (see Section 11.3.6, page 57).</li> </ul>
	<p>It is possible that no PV generation meter is connected to the Sunny Home Manager and that too many data capture devices are simultaneously accessing the devices of your PV system.</p> <p><b>Corrective measures:</b></p> <ul style="list-style-type: none"> <li>• Ensure that, apart from the Sunny Home Manager, a maximum of two other data capture devices are accessing your system at any one time.</li> </ul>

Problem	Cause and corrective measures
No data is displayed on the <b>Current</b> tab on the page <b>Load Balance and Control</b> .	<p>Too many data capture devices may be simultaneously accessing the devices of your system.</p> <p><b>Corrective measures:</b></p> <ul style="list-style-type: none"> <li>• Ensure that, apart from the Sunny Home Manager, a maximum of two other data capture devices are accessing your system at any one time.</li> </ul>
No data is displayed on the <b>Current</b> tab on the page <b>Energy Balance</b> .	<p>It is possible that no PV generation meter is connected to the Sunny Home Manager and that too many data capture devices are simultaneously accessing the devices of your system.</p> <p><b>Corrective measures:</b></p> <ul style="list-style-type: none"> <li>• Ensure that, apart from the Sunny Home Manager, a maximum of two other data capture devices are accessing your system at any one time.</li> </ul>
After a device has been replaced using the configuration wizard, the current parameters are not displayed in the parameter list.	<p>It is possible that the new parameters have not yet been transferred to Sunny Portal.</p> <p><b>Corrective measures:</b></p> <ul style="list-style-type: none"> <li>• Call up the parameter list again later.</li> </ul>

## 18.6 Network problems

### 18.6.1 Using the Sunny Home Manager Assistant in case of network problems

The Sunny Home Manager Assistant only has to be used in exceptional cases.

The Sunny Home Manager Assistant will help you configure the Sunny Home Manager for your network if the Sunny Home Manager does not automatically connect to Sunny Portal.

In addition, you can use the Sunny Home Manager Assistant to display the latest connection status to Sunny Portal and the network settings and the connected BLUETOOTH devices, and save these as a log file. If servicing should be necessary, the Service can use this log file to analyze the problem.

The following operating systems are supported by the Home Manager Assistant (firewall shares may need to be confirmed when using for the first time):

- Microsoft Windows from version Vista
- Linux from Kernel 2.6.12 with Java Runtime Environment version 6
- Apple macOS from version 1.6, with Java Runtime Environment from version 6

#### Procedure:

1. Use a network cable to connect the computer to the same router to which the Sunny Home Manager is also connected.
2. In the download area at [www.SMA-Solar.com](http://www.SMA-Solar.com), download the Sunny Home Manager Assistant for the operating system of your computer.
3. Start the Sunny Home Manager Assistant by double-clicking on the file name.
4. Follow the Sunny Home Manager Assistant instructions.

## 18.6.2 Error in the Sunny Home Manager Assistant

Problem	Cause and corrective measures
The Sunny Home Manager Assistant does not detect a Sunny Home Manager.	<p>The computer with the Sunny Home Manager Assistant is not connected to the router to which the Sunny Home Manager is connected.</p> <p><b>Corrective measures:</b></p> <ul style="list-style-type: none"> <li>• Connect the computer with the Sunny Home Manager Assistant to the router to which the Sunny Home Manager is connected.</li> </ul>

## 18.7 Messages concerning Active Power Limitation in the System Logbook

Problem	Cause and corrective measures
Message in the system logbook: <b>Supplied power has exceeded the permitted value several times.</b>	<p>Although the function <b>Limitation of active power feed-in</b> is activated, more than the maximum permitted active power has been fed into the utility grid.</p> <p><b>Corrective measures:</b></p> <ul style="list-style-type: none"> <li>• Ensure that the feed-in meter is configured correctly (see Section 9.1.4, page 32).</li> <li>• For the inverter ensure that the parameter <b>Operating mode active power</b> is set to <b>External setpoint</b> or for devices with web UI.</li> </ul>
Message in the system logbook: <b>Act. power limitation deactivated due to incorr. configuration.</b>	<p>The function <b>Limiting of the active power feed-in</b> was deactivated by Sunny Home Manager because the system configuration in Sunny Portal was faulty.</p> <p><b>Corrective measures:</b></p> <ul style="list-style-type: none"> <li>• This message can appear while making changes to the Sunny Home Manager system, e.g. upon device replacement. In this case, no action is needed.</li> <li>• If the message appears over an extended time period, contact the Service (see Section 22, page 130).</li> </ul>
Message in the system logbook: <b>Event: act. power limitation activated w/o regard to own consumption</b>	<p>The function <b>Limiting of the active power feed-in</b> is faulty because there is no data from the feed-in meter. Risk of yield loss because the self-consumption of the household cannot be taken into account.</p> <p><b>Corrective measures:</b></p> <ul style="list-style-type: none"> <li>• Ensure that the feed-in meter is working and correctly connected.</li> </ul>
Message in the system logbook: <b>Inverter does not respond to active power limitation</b>	<p>At least one inverter is not responding to limit the active power feed-in.</p> <p>In this case, the Sunny Home Manager initiates stronger active power limitation in the remaining inverters. Consequently, the maximum permitted active power feed-in is complied with.</p> <p>If the message <b>Fed-in power has repeatedly exceeded the permitted value</b> appears on the same day, an error is present.</p> <p><b>Corrective measures:</b></p> <ul style="list-style-type: none"> <li>• For the inverter ensure that the parameter <b>Operating mode active power</b> is set to <b>External setpoint</b> or for devices with web UI.</li> </ul>

## 18.8 Devices with Communication via Data Exchange Protocol

Devices having a specific interface for data exchange, e.g. SEMP or EEBus, can communicate directly with the Sunny Home Manager via a so-called EM (Energy Management) gateway.

Problem	Cause and corrective measures
Message in the system logbook: <b>EM gateway not found:</b> <b>XXXX, name:*</b>	<p>The gateway is not connected to the local network.</p> <p><b>Corrective measures:</b></p> <ul style="list-style-type: none"> <li>• Check whether all network cable plugs are inserted and locked.</li> </ul> <hr/> <p>The voltage supply of the gateway is faulty.</p> <p><b>Corrective measures:</b></p> <ul style="list-style-type: none"> <li>• Check whether the power plug of the gateway is plugged into the outlet.</li> </ul> <hr/> <p>The gateway could not be found by the Sunny Home Manager.</p> <p><b>Corrective measures:</b></p> <ul style="list-style-type: none"> <li>• Restart the gateway (see manual of the gateway).</li> </ul>
Message in the system logbook: <b>EM gateway not found:</b> <b>XXXX, name:*</b>	<p>The Sunny Home Manager and the gateway are located in different local networks.</p> <p><b>Corrective measures:</b></p> <ul style="list-style-type: none"> <li>• Connect the gateway and the Sunny Home Manager to the same network switch/router.</li> </ul> <hr/> <p>The Sunny Home Manager and the gateway are configured for different IP subnets.</p> <p><b>Corrective measures:</b></p> <ul style="list-style-type: none"> <li>• If your router supports DHCP, configure the Sunny Home Manager (default setting) and the gateway to DHCP (see manual of the gateway).</li> <li>• If your router does not support DHCP, manually assign IP addresses in the same subnet for the Sunny Home Manager and the gateway (see manual of the respective device).</li> </ul> <hr/> <p>The voltage supply of the device is faulty.</p> <p><b>Corrective measures:</b></p> <ul style="list-style-type: none"> <li>• Check whether the power plug of the device is plugged into the outlet.</li> </ul>

Problem	Cause and corrective measures
<p>Message in the system logbook:  <b>EM gateway not found: XXXX, name:*</b></p>	<p>The device is not connected to its gateway.</p> <p><b>Corrective measures:</b></p> <ul style="list-style-type: none"> <li>• Check whether the communication between the device and the gateway is working. The device might be outside the range of its gateway (e.g. with power-line communication).</li> </ul> <hr/> <p>The device could not be found by the Sunny Home Manager.</p> <p><b>Corrective measures:</b></p> <ul style="list-style-type: none"> <li>• Restart the device (see manual of the device).</li> </ul> <hr/> <p>One or more devices are not correctly configured in the gateway or for the smart grid.</p> <p><b>Corrective measures:</b></p> <ul style="list-style-type: none"> <li>• Configure the device for its gateway (see manual of the gateway).</li> <li>• Configure the device for the smart grid (see manual of the respective device).</li> </ul>
<p>Message in the system logbook:  <b>Communication with the EM gateway disturbed: XXXX, name:*</b></p>	<p>The gateway is not connected to the local network.</p> <p><b>Corrective measures:</b></p> <ul style="list-style-type: none"> <li>• Check whether all network cable plugs are inserted and locked.</li> </ul> <hr/> <p>The gateway is not communicating correctly with the Sunny Home Manager.</p> <p><b>Corrective measures:</b></p> <ul style="list-style-type: none"> <li>• Restart the gateway (see manual of the gateway).</li> </ul>
<p>Message in the system logbook:  <b>Communication with the EM gateway disturbed: XXXX, name:*</b></p>	<p>The device is not communicating correctly with its gateway.</p> <p><b>Corrective measures:</b></p> <ul style="list-style-type: none"> <li>• Check whether the communication between the device and the gateway is working. The device might be outside the range of its gateway (e.g. with power-line communication).</li> <li>• Restart the gateway (see manual of the gateway).</li> <li>• Restart the device (see manual of the device).</li> </ul>
<p>Message in the system logbook:  <b>EM gateway has incompatible firmware: XXXX, name:*</b></p>	<p>The supported firmware version is not installed on the gateway.</p> <p><b>Corrective measures:</b></p> <ul style="list-style-type: none"> <li>• Update the gateway to the supported firmware version (see manual of the gateway).</li> </ul>
<p>Message in the system logbook:  <b>EM communication: An internal error has occurred (error number: YYYY**)</b></p>	<p>A software error has occurred on the Sunny Home Manager.</p> <p><b>Corrective measures:</b></p> <ul style="list-style-type: none"> <li>• Reset the Sunny Home Manager (see Section 11.6.1, page 64)</li> </ul>

\* "XXXX" is a placeholder for the used data exchange protocol SEMP or EEBus).

\*\* "YYYY" is a placeholder for the respective 4-digit error number.

## 19 Decommissioning

### 19.1 Decommissioning the Sunny Home Manager

#### **⚠ QUALIFIED PERSON**

##### Procedure:

- Disconnecting the Sunny Home Manager from the voltage supply
- Removing the cables and dismantling the Sunny Home Manager

#### Disconnecting the Sunny Home Manager from the voltage supply

#### **⚠ DANGER**

##### **Danger to life due to electric shock**

Lethal voltages are present at the connection point of the utility grid.

- Disconnect the connection point from the utility grid via the disconnection device (e.g. in the distribution board).

#### Removing the cables and dismantling the Sunny Home Manager

1. Unplug the network cable from the network terminal of the Sunny Home Manager.
2. Unplug the other end of the network cable from the router.
3. Remove the Sunny Home Manager from the top-hat rail:
  - Press the top-hat rail locking mechanism located underneath the Sunny Home Manager downwards using a screwdriver. Tilt the lower edge of the Sunny Home Manager forwards and remove upwards from the top-hat rail.

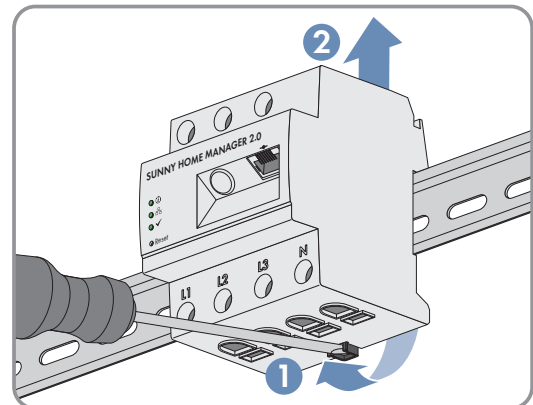

### 19.2 Packing the Product for Shipment

- Pack the product for shipping. Use the original packaging or packaging that is suitable for the weight and size of the product.

### 19.3 Disposing of the Product

- Dispose of the product in accordance with the locally applicable disposal regulations for electronic waste.

## 20 Appendix

### 20.1 List of Compatible SMA Inverters

Device type		From inverter firmware version
Sunny Boy	SB 3000TL-21 / SB 3600TL-21 / SB 4000TL-21 / SB 5000TL-21 / SB 6000TL-21	2.00.00.R*
	SB 3600SE-10 / SB 5000SE-10	2.3.35.R
	SB1.5-1VL-40 / SB2.5-1VL-40 / SB2.0-1VL-40	2.03.01.R
	SB3.0-1AV-40 / SB3.6-1AV-40 / SB4.0-1AV-40 / SB5.0-1AV-40	1.02.18.R
	SB3.0-1AV-41 / SB3.6-1AV-41 / SB4.0-1AV-41 / SB5.0-1AV-41 / SB6.0-1AV-41	3.10.18.R
	SB 2500TLST-21 / SB 3000TLST-21 With data module SWDM-10	2.00.27.R*
Sunny Boy Storage	SBS2.5-1VL-10	02.02.01.R
	SBS3.7-10 / SBS5.0-10 / SBS6.0-10	01.00.63.R
Sunny TriPower	STP3.0-3AV-40 / STP4.0-3AV-40 / STP5.0-3AV-40 / STP6.0-3AV-40 / STP8.0-3AV-40 / STP10.0-3AV-40	02.11.09.R
	STP 50-40	01.01.19.R
	STP 8000TL-10 / STP 10000TL-10 / STP 12000TL-10 / STP 15000TL-10 / STP 17000TL-10	2.33.02.R*
	STP 5000TL-20/STP 6000TL-20/STP 7000TL-20/STP 8000TL-20/STP 9000TL-20/STP 10000TL-20/STP 12000TL-20	2.00.15.R
	STP 15000TLEE-10 / STP 20000TLEE-10	2.10.20.R
	STP 15000TL-30 / STP 20000TL-30 / STP 25000TL-30	02.80.04.R
Sunny Island	SI 6.0H- / SI 8.0H	01.00.xx.R
	SI3.0M-11 / SI4.4M-11	1.00.00.R
	SI3.0M-11 / SI4.4M-11 / SI6.0H-11 / SI8.0-11 With SMA Speedwire data module Sunny Island	
	SI4.4M-12 / SI6.0H-12 / SI8.0H-12	01.00.xx.R
	SI6.0H-13 / SI8.0H-13	3.20.09.R

\* This firmware version is the minimum requirement for the function **Limiting of the active power feed-in**.

## 21 Technical Data

### Energy Manager

Connection to the local router	via Ethernet cable (10/100 Mbit/s, RJ45 plug)
Connection of SMA PV inverters and battery systems	Ethernet or WLAN via local router
Connection of loads in the energy management (for examples of applications for appliance connection and controls, see technical information on the Sunny Home Manager 2.0 product page at <a href="http://www.SMA-Solar.com">www.SMA-Solar.com</a> )	<ol style="list-style-type: none"> <li>1. Direct data connection (EEBUS, SEMP) <ul style="list-style-type: none"> <li>• e.g. intelligent heat pumps, electric car charging stations, heating elements, home appliances, etc.</li> </ul> </li> <li>2. Indirect connection via radio-controlled socket (available from electronics retailers) <ul style="list-style-type: none"> <li>• e.g. on/off controls for home appliances of up to 12 A of power</li> </ul> </li> </ol>

### Integrated measuring device

Measurement accuracy, measuring cycle	1%; 200, 600 or 1000 ms (standard: 1000 ms)
Standard application	Measurement of purchased electricity and grid feed-in at the grid connection point
Alternative application	<ol style="list-style-type: none"> <li>1. Measurement of PV generation power</li> <li>2. Measurement inactive (L1, N, network)</li> </ol>

### Max. number of devices on the system (excluding the SMA Energy Meter)

Total number of devices in the system	up to 24
<ul style="list-style-type: none"> <li>• of which devices as loads in active energy management</li> </ul>	up to 12

### Inputs (voltage and current)

Nominal voltage	230 V / 400 V
Frequency	50 Hz/±5%
Nominal current/limiting current per line conductor	5 A/63 A (>63 A can be covered via external current transformers)
Connection cross-section	10 mm <sup>2</sup> to 16 mm <sup>2</sup> (for 63 A application)
Torque for screw terminals	2.0 Nm

### Ambient Conditions in Operation

Ambient temperature	-25°C to +40°C
Storage temperature range	-25°C to +70°C
Protection class (according to IEC 62103)	II
Degree of protection (to IEC 60529)	IP2X



Maximum permissible value for the relative humidity (non-condensing)	5% to 90%
Altitude above MSL	0 m to 2,000 m

### General Data

Width x height x depth	70 mm x 88 mm x 65 mm
Individual units DIN rail	4
Weight	0.3 kg
Mounting location	Switch or meter cabinet
Mounting type	Top-hat rail mounting
Status display	3 x LED
Self-consumption	< 3 W

### Equipment

Operation and visualization	via Sunny Portal, Sunny Places, Sunny Portal Pro
Update function	Automatic for the Sunny Home Manager and the connected SMA devices
Warranty	2 years
Certificates and approvals	<a href="http://www.SMA-Solar.com">www.SMA-Solar.com</a>

### Accessories

SMA Energy Meter as complement to integrated Measuring devices	Precise three-phase measuring, connection via Ethernet in the local network.
Model number	HM-20

## 22 Contact

If you have technical problems with our products, please contact the SMA Service Line. The following data is required in order to provide you with the necessary assistance:

- Serial number and software package of the Sunny Home Manager
- Manufacturer, serial number and firmware version of the radio-controlled socket
- Name of the Sunny Home Manager system
- Type of energy meters

Deutschland	SMA Solar Technology AG	Belgien	SMA Benelux BVBA/SPRL
Österreich	Niestetal	Belgique	Mechelen
Schweiz	Sunny Boy, Sunny Mini Central, Sunny Tripower, Sunny Highpower: +49 561 9522-1499	België	+32 15 286 730
	Monitoring Systems, SMA EV Charger: +49 561 9522-2499	Luxemburg	for Netherlands: +31 30 2492 000
	Hybrid Controller: +49 561 9522-3199	Luxembourg	SMA Online Service Center: www.SMA-Service.com
	Sunny Island, Sunny Boy Storage, Sunny Backup: +49 561 9522-399	Nederland	
	Sunny Central, Sunny Central Storage: +49 561 9522-299	Česko	SMA Service Partner TERMS a.s +420 387 6 85 111
	SMA Online Service Center: www.SMA-Service.com	Magyarország	SMA Online Service Center: www.SMA-Service.com
		Slovensko	
		Türkiye	SMA Service Partner DEKOM Telekomünikasyon A. Ş +90 24 22430605
			SMA Online Service Center: www.SMA-Service.com
France	SMA France S.A.S.	Ελλάδα	SMA Service Partner AKTOR FM.
	Lyon	Κύπρος	Αθήνα
	+33 472 22 97 00		+30 210 8184550
	SMA Online Service Center: www.SMA-Service.com		SMA Online Service Center: www.SMA-Service.com
España	SMA Ibérica Tecnología Solar, S.L.U.	United Kingdom	SMA Solar UK Ltd.
Portugal	Barcelona		Milton Keynes
	+34 935 63 50 99		+44 1908 304899
	SMA Online Service Center: www.SMA-Service.com		SMA Online Service Center: www.SMA-Service.com
Italia	SMA Italia S.r.l.	Australia	SMA Australia Pty Ltd.
	Milano		Sydney
	+39 02 8934-7299		Toll free for Australia: 1800 SMA AUS (1800 762 287)
	SMA Online Service Center: www.SMA-Service.com		International: +61 2 9491 4200

United Arab Emirates	SMA Middle East LLC Abu Dhabi +971 2234 6177 SMA Online Service Center: www.SMA-Service.com	India	SMA Solar India Pvt. Ltd. Mumbai +91 22 61713888
ไทย	Service Partner for String inverter: Solar Power Engineering Co., Ltd. 333/7,8,9 United Tower Building 4th floor. Soi Sukhumvit 55 (Thonglor 17), Klongton Nua, Wattana, 10110 Bangkok, Thailand +66 20598220 smaservice@spe.co.th Service Partner for Utility: Tirathai E & S Co., Ltd 516/1 Moo 4, Bangpoo Industrial Estate Sukhumvit Road, T. Praksa, A. Muang 10280 Samutprakarn, Thailand +63 1799866 servicepartner.sma@tirathai.co.th	대한민국	Enerone Technology Co., Ltd 4th Fl, Jungbu Bldg, 329, Yeongdong-daero, Gangnam-gu, Seoul, 06188, Korea +82-2-520-2666
		Argentina	SMA South America SPA
		Brasil	Santiago de Chile
		Chile	+562 2820 2101
		Perú	
		South Africa	SMA Solar Technology South Africa Pty Ltd. Cape Town 08600SUNNY (08600 78669) International: +27 (0)21 826 0699 SMA Online Service Center: www.SMA-Service.com
Other countries	International SMA Service Line Niestetal 00800 SMA SERVICE (00800 762 7378423) SMA Online Service Center: www.SMA-Service.com		

